

Special-Sensors for Automation



Level Sensors

Contents

Application notes	2.03 - 2.07
--------------------------------	-------------

Level Sensors

Microwave meter Series MFP	2.08 - 2.12
Microwave meter Series MFM.....	2.13
Microwave-Compact Series MFC	2.14
Microwave-Compact Series MFK	2.15
Capacitive sensors-compact Series KGF / KGMR / KGFR / KA / KB / KFC.....	2.16 - 2.21
Opto switch-compact Series UFGS / UFS	2.22 - 2.23
Conductive compact model Series CFC	2.24
Hydrostatic level meter Series DGC	2.25
Capacitive analog-sensors up to 200 °C Series KFA.....	2.26
Capacitive -230 °C-Low temperature Series KGFP	2.27
Capacitive 230 °C-High temperature Series KGFT / KGFT-CER	2.28 - 2.29
Capacitive amplifiers Series KK / KU / KUA.....	2.30 - 2.31

Level Sensors for Ex-applications

Ex-sensors Zone 20 - 22 Series KGEX	2.32 - 2.33
Ex-opto sensors Zone 0 Series UFGS...Ex / URFG...Ex	2.34 - 2.35
Ex-sensors Zone 0 - 1 Series TF...Ex.....	2.36
Ex-sensors Zone 0 Series KEAC	2.37
Ex-sensors Zone 0 up to 200 °C Series KGFT...Ex	2.38
Ex-Preamplifier Series KK 030 Ex	2.38
Ex-amplifiers Series IKM 122 Ex / IKM 123 Ex.....	2.39 - 2.40
Ex-amplifier Zone 1 Series SF3.....	2.41
Ex-housing for amplifiers Zone 1/21 System GAM.....	2.42
Ex-housing for screw terminals Zone 1/21 Series GK.....	2.43

Accessories

Mounting sleeves	2.44
M12 connector	2.45
Assembly parts.....	2.46

We reserve the right to make technical alterations without prior notice.

Application notes

Microwave meter

The MFP and MFM level meter for continuous monitoring of various liquids allow measurement of the fill level in plastic or metal tanks of any size. The devices offer a high measurement precision. They work with numerous liquids such as water, oil or emulsions.

Principle of measurement: The microwaves are “guided” along the rod – and are reflected at the surface of the medium. From this the sensor determines the fill level. No adjustment is necessary for various media.

The devices are made of aluminium and AISI 316 Ti stainless steel and are suitable for ambient temperatures between –20 and +70 °C. Additional devices are available for monitoring highly corrosive liquids with a coated probe and non-metallic thread.

The fill level meters are available in sizes between 300 and 1100 mm in length. The sensors are equipped with a G3/4 thread and are connected via an M12 plug. The display shows the fill level either in cm or percentage value. You can program additional functions such as a fixed offset value or measuring range.

Microwave level controllers

The microwave level controllers of the MFC and MFK series respond to media contact at the tip of the sensor. They are especially insensitive to soiling and build-up. The devices of the MFK series are made of stainless steel and PTFE and are equipped with a G1/2 process connection. The sensors have a length of 40 mm. Thanks to their integrated electronics, no downstream amplifier is required. The sensors do not have to be adjusted to different media, and for containers made of plastic material, no earth connection is required.

Users can adjust the sensitivity of the devices of the MFC series using a pushbutton. Thus, the sensors can distinguish between different layers of liquids (e.g. water and oil) in the containers allowing for an easy separation of liquids. The stainless steel and PTFE microwave sensors can be used for virtually all container types and sensor environments. They are also suited for use with powder or granules. The sensors are available with a length of between 120 mm and 1000 mm thus offering various different installation options.

Capacitive sensors

The operation of these level sensors is based on a dielectric measuring method. All media which are surround the sensors measuring electrode, built into the tip of the probe, change the state of dielectric balance between the measuring electrode and the surrounding space. This disturbance in the balance triggers a switching command inside the device. The balance can be adjusted with a built-in potentiometer so that materials with different bulk densities and correspondingly different dielectric con-

stants can be measured optimally. Metallic or metal clad vessels should be earthed. In the case of plastic vessels filled with electrically conductive materials, the latter should be earthed. In the case of plastic vessels filled with non-conducting materials, an earthed metal band applied on the outside of the vessel may be used as a counter-electrode.

Medium adjustment for capacitive sensors

Level sensors are set in such a way that they switch upon contact with a medium. The medium adjustment should, if possible, take place without removal under operating conditions. If the built-in part of the sensor can be completely submerged or covered during operation, the adjustment must also take place in this state. If only medium contact is possible, the adjustment takes place upon contact. The trimmer potentiometer is protected by a plastic bolt. This bolt must be removed before the desired sensitivity is set. Turning it clockwise increases the response sensitivity. The adjustment potentiometer is turned until the switch output switches through (normally-open contact). You achieve switching point safety by continuing to turn the potentiometer half a turn to one turn. Devices with a LED line are adjusted to two green LEDs. If the medium adjustment has taken place, the plastic bolt must be fixed again.

Laboratory adjustment

If adjustment cannot be carried out with the sensor mounted in operating position, it can be performed upon a similar vessel. It must, however, be made sure that this vessel is set upon an earthed metal plate, or that the liquid within the vessel is earthed by means of an introduced wire. The minimum height and minimum diameter of the experimental vessel should be about 10 cm.

If setting is correct, the filling level monitor reacts correctly if 50% of the electrode diameter is covered. When mounted vertically, sensors reacts upon contact with the medium. Reaction time lag is less than 0.25 sec.

Application notes

Opto-sensors UF../UR..

Optical sensors react to a change of the refraction index within the proximity of the sensor tip when being immersed into fluid. The sensor does not have to be adjusted. In rare cases, the container wall or particles within the fluid may reflect the light emitted by the sensor and thus interfere with the fluid detection. A trial run is recommended in such instances. The sensors are designed to be used with the respectively listed fluids under normal conditions. The chemical compatibility and technical suitability of the sensor should be tested when used with unlisted fluids.

Resistance UFGS..., UFGS...Ex, URFG...Ex

Water / water steam	Monoethylenglycole
Vegetable oil	Glyceric
Diluted acids	Acetone
Diluted bases	Fuels
Ethyl alcohol	Benzol
Methyl alcohol	Diesel
Isopropanol	Motor oil
Isohexan	Hydraulic oil
n-Heptan	Paraffin Oil DAB

Conductive level controller

The CFC 050 GSOP enables level detection of fluids with a conductivity $>10 \mu\text{S/cm}$. Typical applications are dry-running protection or overflow protection in vessel or pipes. The CFC 050 GSOP works with a measuring electrode and a complementary electrode which is connected to the metallic thread. The switching signal is triggered when the fluid has contact to both electrodes.

Adhesions or splash are no problem. Using the screw-on-electrode the CFC 050 GSOP can even be used in plastic container. The electrodes can easily be shortened by the user.

Medium (example)	Conductivity ($\mu\text{S/cm}$)
Concentrated acid or alkaline	up to 1000 000
Industrial contaminated water	up to 500 000
Methylalcohol	440 000
Seawater	55 000
Ethylalcohol	1300
Drinking water	100...2000
Distilled water	0.5...5
Organic or mineral oils	0

Hydrostatic fill level sensor

The hydrostatic fill level sensors of the series DGC 075 are suitable for fill level measuring in liquids and are available for fill levels up to 500 cm. The measuring range can be adjusted simple and fast by potentiometer and 4 LEDs on the measuring head. It is easy to install with its G3/4 thread, for example in the tank wall, and has protection class IP 67. The sensor has a 4...20 mA signal exit.

Sensors for explosion hazardous areas

Fill level monitors for use in zone 0 or zone 20 are operated with the associated amplifiers listed in the respective connection chart. The analysis devices operated outside of the Ex area. Sensors of the series KGFT...Ex are used in conjunction with an intermediate amplifier, which is approved for installation in zone 1. Optical Ex sensors URFG-Ex and thermal level sensors TF...Ex can also be driven with the amplifier SF3 for application in zone 1.

Thermal level controllers for hazardous areas

EGE provides the TFKS and TFGS series of thermal level controllers for explosive gas atmospheres (zone 0 and 1). The sensors are suitable for stationary and mobile use, e.g. in gasoline or diesel tank trucks. Featuring a G3/4 thread, the devices are available with a maximum length of 400 mm or with a fixed immersion depth. They are connected to SF3 amplifier units. Both sensor types have a nominal resistance of 160Ω . Manufactured from aluminum or stainless steel 1.4571, TFKS and TFGS sensors provide IP 68 protection and are suitable for ambient temperatures between -20 and $+80 \text{ }^\circ\text{C}$. They are connected via M12 plugs.

Glossary

Switching point

Capacitive level sensors react to conductive materials and non-conductive materials with a dielectrical constant $\epsilon > 1$. The switching point depends on the material.

In the same installation situation, sensors are more sensitive when using conductive materials.

When the sensor-tip is immersed in a fluid, a switching command inside the device is triggered. This trigger is set between contact with the liquid and some mm more into the liquid. This distance between the tip of the sensor and the trigger is the nominal switching point. The immersion-distance has a negative sign, e. g. -8 mm .

The water content of an object or a liquid has a decisive influence on the switching point. A high humidity content increases the switching point considerably.

Application notes

Switching point s_p

The switching point or rated operating distance is a device parameter that does not take into account sample variances and external influences such as temperature and supply voltages. Optical sensors are switching by immersing the tip. When the sensor tip is immersed in a fluid, the switching point has a negative sign.

Effective operating distance s_r

The effective operating distance is the operating switching point at nominal voltage and at nominal temperature of 23 °C. It is between 90% and 110% of the rated operating distance.

Usable operating distance s_u

The usable operating point is in the entire allowable temperature and voltage range is between 80% and 120% of the effective operating distance.

Assured operating distance s_a

The assured operating point takes into account all the external influences, sample and media variances and is in the range from 0% to 72% of the rated operating distance point. Within this range a guaranteed switching is ensured.

Switching point drift

The operating distances are given for an ambient temperature of 23 °C. In the permissible temperature range the switching point varies by less than 15% from the value at 23 °C. The temperature of the measured object has no influence on the switch point.

Hysteresis H

The switching hysteresis describes the distance between the turn on point while immersing in the liquid and the turn off point during the separation of it from the sensor. The hysteresis brings about a stable switching signal even when there are vibrations, temperature drift, or electrical failures. The hysteresis is defined according to EN 60947-5-2 to be a maximum 20% from the real switching point, and carries a value of typically 10% - 15% from the real switching distance s_r for EGE sensors.

Repeating accuracy R

The repeating accuracy describes the maintenance of the switching point after the repeated immersing in the liquid under specified circumstances. EGE sensors have typical tolerances of less than 3% of the effective operating point.

Switching frequency

The maximum switching frequency of the sensor is determined at nominal switching point S_p when immersing in the water.

Supply voltage

The operating voltage is the voltage range in which EGE sensors function safely. For a constant voltage supply it is important to make sure that the limits are still observed when the residual ripple is included.

Switching current

This current gives the maximum long-term current for the switching output of the sensor at an ambient temperature of 25 °C and ohmic load. At an elevated ambient temperature, the current load capability decreases.

For analog outputs, the boundary values given in the appropriate technical data, and particularly the permissible values for resistance loads, must be observed.

Short circuit protection

The short circuit proof ensures the sensor against destruction through a short circuit on the output. After removal of the fault, the output is reactivated. Where a maximum overload current is listed, this should not be exceeded.

Overcurrent release

This value indicates the median value of current at which the short circuit protection responds with a tolerance of $\pm 20\%$.

Reverse polarity protection

The reverse polarity protection prevents destruction of the sensor by a reversal of the polarity of the voltage supply.

Voltage drop U_d

The voltage drop arises at the internal resistance of semiconductor elements, which are in the current-path of the output. It is dependent of the load-current and is declared according to EN 60947-5-2 for a mean current of 50 mA.

Residual current I_r

The residual current flows in the load current circuit when the output is blocked. The residual current must be considered when switching sensors in parallel.

Minimum load current I_m

The minimum load current is necessary for flawless operation with two-wire devices.

Current consumption

The current consumption is the maximum value of the no-load current I_0 that the sensor can absorb without a load.

Ambient temperature

The ambient temperature indicates the maximum allowable temperature range for the sensor.

Electromagnetic compatibility EMC

The EMC class is a measure of the noise immunity of the sensor against external electrical and magnetic influences. The information is based on the standard EN 61000-6-2.

Application notes

Switch-on impulse suppression

EGE sensors have a switch-on impulse suppression that blocks the output during the switch-on phase, when the operational voltage is applied.

Protection

The protective system indicates the protection of the sensors against penetration of foreign bodies and water according to EN 60529.

LED-Display

EGE sensors with yellow light-emitting diodes indicate the switching status optically.

Housing material

The housing material determines the chemical resistance of the sensor against external influences. For special applications, other housing materials are available.

Connection

The connection of the sensors is accomplished through plug-in connections or cables. Different cable types and lengths are available upon request.

Instructions for mounting

The sensor tip of short level sensors installed from the side must be located inside the container. To prevent build-up, it is recommended to install these sensors at a tilted angle of approx. 20°. With rod-style sensors, make sure that the tip is not affected by lateral forces. Such forces may occur, for example, when using sensors near filling openings or mixers.

Only use materials for housing and sealing that are suitable for the respective application.

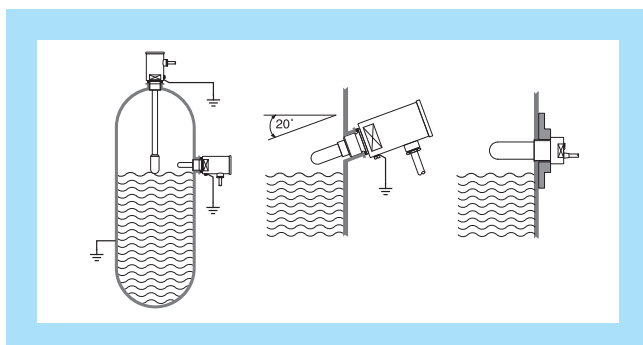

For flush mounting, the sensor can be built into influencing material up to its active surface without changing its characteristics. For non-flush mounting, a metal-free zone around the sensor must be allowed for. A free zone to the material opposite the sensor must be maintained for all sensors.

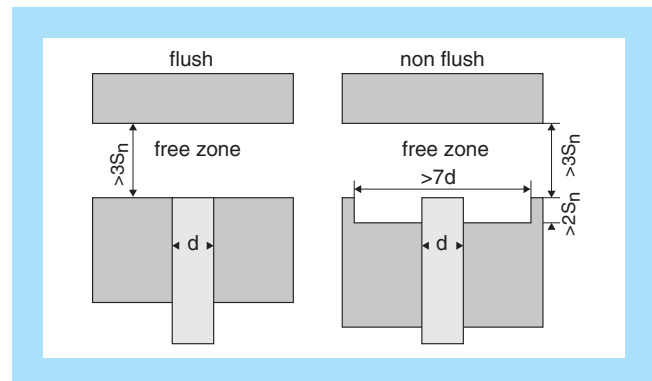

The indicated free zones are in accordance with the standard EN 60947-5-2.

Collocation

When collocating the sensors, a minimum separation must be kept between the devices in order to avoid mutual influence. When in doubt, a test should be conducted under application conditions. For capacitive sensors, the lateral separation from one another must correspond to at least twice the diameter of the sensor. For separations greater than eight times the diameter no mutual influence is to be expected. For oppositely mounted sensors, a minimal separation of eight times the nominal switching separation should be allowed for.

Threads

The threads of the sensors in this prospectus are manufactured to DIN ISO 228-1, tolerance class B. They are designated with (") or (G).

If it is necessary to combine different threads, e.g. the sensor-thread made to DIN ISO 228-1 and an inner thread made to DIN ISO 229, such inner thread must be widened by a thread drill.

Torques

In order to prevent destruction of the threaded bushing during fitting, PTFE-sensors may only be tightened by hand.

Colour code: BK = black BN = brown BU = blue GN = green YE = yellow GY = grey PK = pink WH = white

Application notes

Sealings

The sealings used for our sensors are made of PTFE, NBR, FPM or AFM. For water applications with water temperatures up to 150 °C and with pressures less than 5 bar, EDPM O-rings must be used. If the temperatures exceed 100 °C or the pressures are higher special sealings are necessary (2). When ordering sensors for such applications, such special sealings must be ordered too.

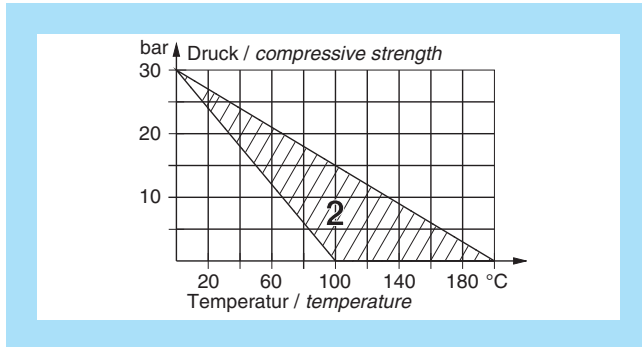

Instructions for operation

Serial connection

For the serial connection of two wire or three wire sensors the individual voltage drops are added together. Therefore there is a lesser operational voltage at the disposal of the load. The addition of the switch-on delay times should be noted.

Parallel connection

The parallel connection of two wire sensors can only be conditionally recommended since the residual currents are added together and flow through the load. For the parallel connection of three wire sensors, the current consumption of the individual devices is added together. Since this current does not flow through the load, the maximum number of parallel connectable three wire sensors depends only on the power supply.

Approval for safety applications

Sensors for personal security must have a qualification approval according to EN 61508 and must be labeled accordingly. Sensors that are not labeled must not be used for applications of this kind.

Valid standards

- EN 60947-5-2
Control units; low voltage control units, auxiliary switch, proximity switch
- EN 61000-6-4
Electromagnetic compatibility (EMC)
Interference emissions in the industrial area
- EN 61000-6-2
Electromagnetic compatibility (EMC)
Generic standards immunity for industrial environments
- EN 61000-4-2 (ESD)
Electrostatic discharging immunity
- EN 61000-4-3 (HF radiated)
Radiated radio-frequency electromagnetic field immunity test
- EN 61000-4-4 (Burst)
Electrical fast transient/burst immunity test
- EN 61000-4-5 (Surge)
Surge immunity test
- EN 60529
Protective systems, IP-designation
- EN 60079-0 : 2012 +A11:2013
Explosive atmospheres –
Part 0: Equipment – General requirements
- EN 60079-7 : 2007
Explosive atmospheres –
Part 7: Equipment protection by increased safety „e“
- EN 60079-11 : 2012
Explosive atmospheres –
Part 11: Equipment protection by intrinsic safety „i“
- EN 60079-18 : 2015
Explosive atmospheres –
Part 18: Equipment protection by encapsulation „m“
- EN 60079-26 : 2015
Explosive atmospheres –
Part 26: Equipment with Equipment Protection Level (EPL)Ga
- EN 60079-31 : 2014
Explosive atmospheres –
Part 31: Equipment dust ignition protection by enclosure „t“

Authorisations

TÜV NORD CERT Zertifizierungsstelle - Deutschland
(technical monitoring certification agency - Germany)

Certification

- TÜV-cert ISO 9001 : 2008
- TÜV-cert Quality control production
Attachment IV of the EC-Guidelines 94/9/EG
DIN EN ISO/IEC 80079-34 : 2012
- TÜV Nord Re-cancelling certificate according to EN 10204

Microwave meter

Series MFP

Analog output or
2x PNP output

High precision

Water-based liquids

Guided Microwave



Design

DC Analog / DC PNP • G3/4

Dimensions

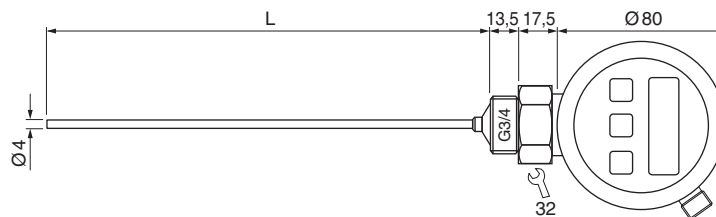

Design	Single probe	Single probe	Sensor length The total length L of the sensors is specified by appending "xxx" to the type. xxx: Length in cm
Output	4...20 mA, linear 	2x PNP, programmable 	
ID-No.	P.....	P.....	
Type-sensor length L	MFP 075 GA-LMxxx	MFP 075 GPP-LMxxx	
Supply voltage [V]	20...27 DC	20...27 DC	
Current consumption [mA]	< 45	< 45	
Current output [mA]	4...20	-	
Load resistance R _L [Ω]	200...500	-	
Switching current [mA]	-	200	
Reverse protection	•	•	
Precision [mm]	5	5	
Transition zone* [mm]	top: 25, bottom: 15	top: 25, bottom: 15	
Ambient temperature [°C]	0...+70	0...+70	
Medium temperature [°C]	0...+80	0...+80	
Sensitivity [ε _r]	≥ 20	≥ 20	
Protection [EN 60529]	IP 67	IP 67	
Housing material	Aluminium		
Material	AISI 316 Ti, PTFE		
Sealing material	NBR, AFM 34, different material on request		
Compressive strength [bar]	10 (25 °C)		
Connection	M12 connector		
	<p>GA</p>		<p>GPP</p>

* Depending on the installation conditions and the medium, deviations from the specified measuring accuracy can occur in this area.

Accessories

connecting cable SLG / SLW 3..., SLG / SLW 4..., see page 2.45

Microwave meter

Series MFP

Analog output or
2x PNP output

High precision

Liquids from
oil to water

Guided Microwave



Design DC Analog / DC PNP • G3/4

Dimensions

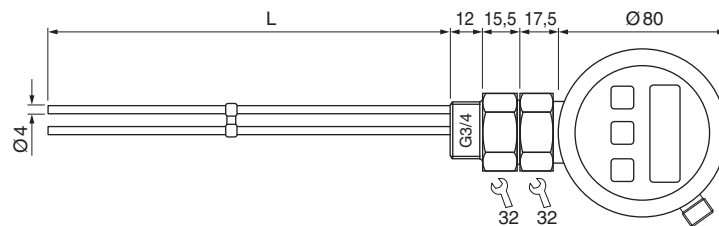

Design	Parallel probe	Parallel probe	
Output	4...20 mA, linear 	2x PNP, programmable 	
ID-No.	P.....	P.....	
Type-sensor length L	MFP 075 GA-LPxxx	MFP 075 GPP-LPxxx	Sensor length The total length L of the sensors is specified by appending "xxx" to the type. xxx: Length in cm
Supply voltage [V]	20...27 DC	20...27 DC	Preferred lengths GA
Current consumption [mA]	< 45	< 45	300 mm: LP030
Current output [mA]	4...20	-	500 mm: LP050
Load resistance R _L [Ω]	200...500	-	800 mm: LP080
Switching current [mA]	-	200	Preferred lengths GPP
Reverse protection	•	•	300 mm: LP030
Precision [mm]	5	5	500 mm: LP050
Transition zone* [mm]	top: 25, bottom: 25	top: 25, bottom: 25	800 mm: LP080
Ambient temperature [°C]	0...+70	0...+70	ID-No.
Medium temperature [°C]	0...+80	0...+80	300 mm: LP030 P21202
Sensitivity [ε _r]	≥ 2	≥ 2	500 mm: LP050 P21203
Protection [EN 60529]	IP 67	IP 67	800 mm: LP080 P21221
Housing material	Aluminium		
Material	AISI 316 Ti, PTFE, POM		
Sealing material	NBR, AFM 34, different material on request		
Compressive strength [bar]	10 (25 °C)		
Connection	M12 connector		

* Depending on the installation conditions and the medium, deviations from the specified measuring accuracy can occur in this area.

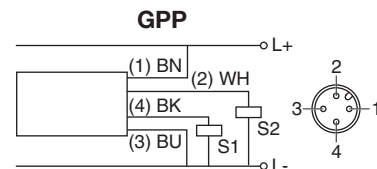
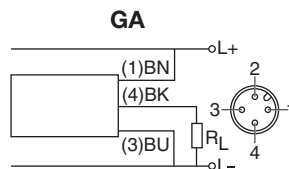

Accessories connecting cable SLG / SLW 3..., SLG / SLW 4..., see page 2.45

Microwave meter

Series MFP





Analog output or
2x PNP output

High precision
Easy cleaning

Liquids from oil to water

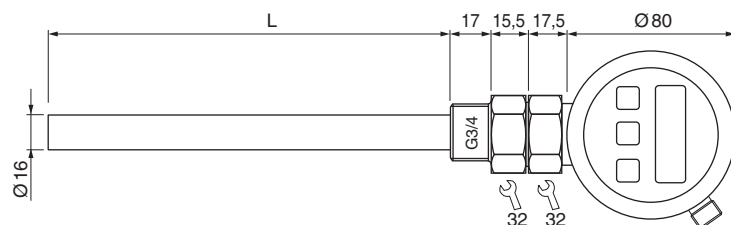
Guided Microwave



Design	DC Analog / DC PNP • G3/4																										
Dimensions																											
Design	Koax probe	Koax probe	<p>Sensor length</p> <p>The total length L of the sensor is specified by appending "xxx" to the type.</p> <p>xxx: Length in cm</p> <p>Preferred lengths GA</p> <table border="0"> <tr> <td>300 mm:</td> <td>LK030</td> <td>ID-No.</td> <td>P21217</td> </tr> <tr> <td>500 mm:</td> <td>LK050</td> <td></td> <td>P21218</td> </tr> <tr> <td>800 mm:</td> <td>LK080</td> <td></td> <td>P21219</td> </tr> </table> <p>Preferred lengths GPP</p> <table border="0"> <tr> <td>300 mm:</td> <td>LK030</td> <td>ID-No.</td> <td>P21214</td> </tr> <tr> <td>500 mm:</td> <td>LK050</td> <td></td> <td>P21215</td> </tr> <tr> <td>800 mm:</td> <td>LK080</td> <td></td> <td>P21216</td> </tr> </table>	300 mm:	LK030	ID-No.	P21217	500 mm:	LK050		P21218	800 mm:	LK080		P21219	300 mm:	LK030	ID-No.	P21214	500 mm:	LK050		P21215	800 mm:	LK080		P21216
300 mm:	LK030	ID-No.		P21217																							
500 mm:	LK050			P21218																							
800 mm:	LK080			P21219																							
300 mm:	LK030	ID-No.		P21214																							
500 mm:	LK050			P21215																							
800 mm:	LK080			P21216																							
Output	4...20 mA, linear 	2x PNP, programmable  NO  NC																									
ID-No.	P.....	P.....																									
Type-sensorenlength L	MFP 075 GA-LKxxx	MFP 075 GPP-LKxxx																									
Supply voltage [V]	20...27 DC	20...27 DC																									
Current consumption [mA]	< 45	< 45																									
Current output [mA]	4...20	-																									
Load resistance R _L [Ω]	200...500	-																									
Switching current [mA]	-	200																									
Reverse protection [mm]	•	•																									
Precision [mm]	5	5																									
Transition zone* [mm]	top: 25, bottom: 25	top: 25, bottom: 25																									
Ambient temperature [°C]	0...+70	0...+70																									
Medium temperature [°C]	0...+80	0...+80																									
Sensitivity [ε _r]	≥ 2	≥ 2																									
Protection [EN 60529]	IP 67	IP 67																									
Housing material	Aluminium																										
Material	AISI 316 Ti, PTFE, POM																										
Sealing material	NBR, AFM 34, different material on request																										
Compressive strength [bar]	10 (25 °C)																										
Connection	M12 connector																										

* Depending on the installation conditions, deviations from the specified measuring accuracy can occur in this area.

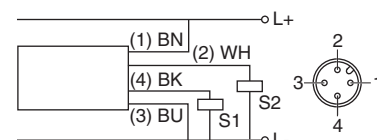
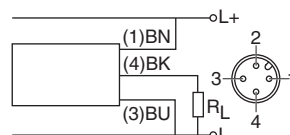

Accessories connecting cable SLG / SLW 3..., SLG / SLW 4..., see page 2.45

Microwave meter

Series MFP

Analog output or
2x PNP output

High precision

Probe surface coated
for aggressiv media

Guided Microwave



Design DC Analog / DC PNP • G3/4

Dimensions

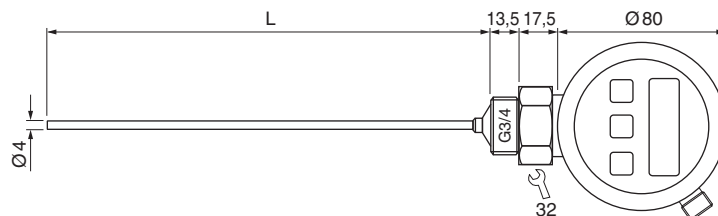

Design	Single probe	Single probe	Sensor length The total length L of the sensors is specified by appending „xxx“ to the type. xxx: Length in cm Preferred lengths single probe ID-No. 300 mm: LMF030 P21229 500 mm: LMF050 P21230 800 mm: LMF080 P21231 Preferred lengths single probe ID-No. 300 mm: LMF030 P21232 500 mm: LMF050 P21233 800 mm: LMF080 P21234 Note: Different lengths available on request.
Output	4...20 mA, linear 	2x PNP, programmable 	
ID-No.	P....	P....	
Type-sensorenlength L	MFP 075 GA-LMFxxx	MFP 075 GPP-LMFxxx	
Supply voltage [V]	20...27 DC	20...27 DC	
Current consumption [mA]	< 45	< 45	
Current output [mA]	4...20	-	
Load resistance RL [Ω]	200...500	-	
Switching current [mA]	-	200	
Reverse protection [mm]	•	•	
Precision [mm]	5	5	
Transition zone* [mm]	top: 40, bottom: 15	top: 40, bottom: 15	
Ambient temperature [°C]	0...+70	0...+70	
Medium temperature [°C]	0...+80	0...+80	
Sensitivity [εr]	≥ 20	≥ 20	
Protection [EN 60529]	IP 67	IP 67	
Housing material	Aluminium		
Material	AISI 316 Ti, PTFE, PFA		
Sealing material	NBR, different material on request		
Compressive strength [bar]	10 (25 °C)		
Connection	M12 connector		

* Depending on the installation conditions and the medium, deviations from the specified measuring accuracy can occur in this area.

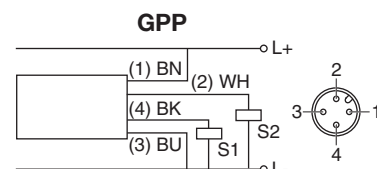
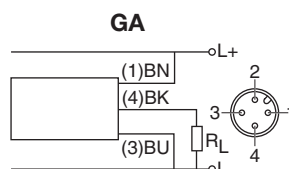

Accessories connecting cable SLG / SLW 3..., SLG / SLW 4..., see page 2.45

Microwave meter

Series MFP

Analog output or
2x PNP output

High precision

Wetted parts are
non-metallic

Guided Microwave



Design

DC Analog / DC PNP • G3/4

Dimensions

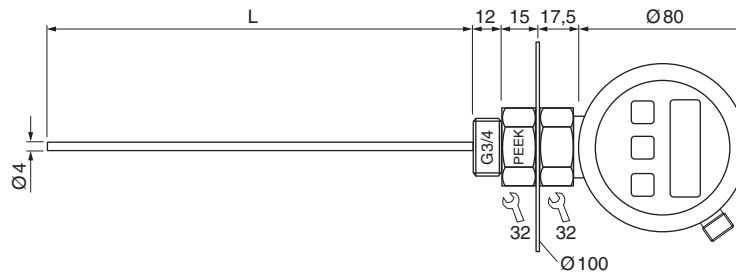

Design	Monostab	Monostab	Sensor length The total length L of the sensors is specified by appending „xxx“ to the type. xxx: Length in cm Preferred lengths single probe 300 mm: LMF030 500 mm: LMF050 Preferred lengths single probe 300 mm: LMF030 500 mm: LMF050 Note: Different lengths available on request.
Output	4...20 mA, linear 	2x PNP, programmable 	
ID-No.	P....	P....	
Type-sensordlength L	MFP 075K GA-LMFxxx	MFP 075K GPP-LMFxxx	
Supply voltage [V]	20...27 DC	20...27 DC	
Current consumption [mA]	< 45	< 45	
Current output [mA]	4...20	-	
Load resistance R _L [Ω]	200...500	-	
Switching current [mA]	-	200	
Reverse protection [mm]	•	•	
Precision [mm]	10	10	
Transition zone* [mm]	top: 40, bottom: 15	top: 40, bottom: 15	
Ambient temperature [°C]	0...+70	0...+70	
Medium temperature [°C]	0...+80	0...+80	
Sensitivity [ε _r]	≥ 20	≥ 20	
Protection [EN 60529]	IP 67	IP 67	
Housing material	Aluminium, AISI 316 Ti		
Material	PEEK, PFA		
Sealing material	NBR, different material on request		
Compressive strength [bar]	10 (25 °C)		
Connection	M12 connector		

* Depending on the installation conditions and the medium, deviations from the specified measuring accuracy can occur in this area.

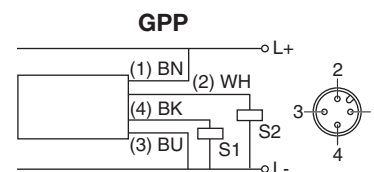
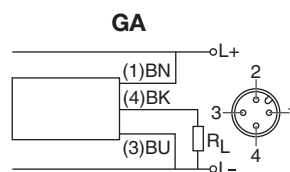

Accessories

connecting cable SLG / SLW 3..., SLG / SLW 4..., see page 2.45

Microwave meter

Series MFM

High precision ± 3 mm

Liquids from
oil to water

Guided microwave



Design

DC Analog • G3/4

Dimensions

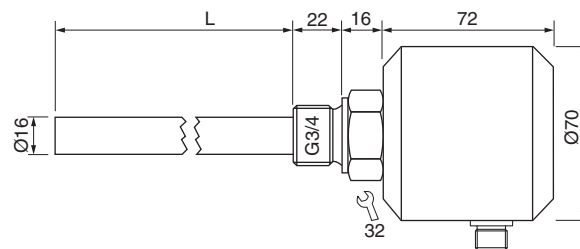

Output



4...20 mA, linear

P21197...

ID-No.

MFM 075 GA-Lxxx

Type-sensor length L

Supply voltage [V]

20...27 DC

Current consumption [mA]

<100

Current output [mA]

4...20

Load resistance R_L [Ω]

200...500

Reverse protection

•

Precision [mm]

± 3

Inactive range [mm]

top: 20, bottom: 30

Ambient temperature [$^{\circ}\text{C}$]

-20...+70

Medium temperature [$^{\circ}\text{C}$]

-20...+80

Sensitivity [ϵ_r]

>1.8

Protection [EN 60529]

IP 67

Sensor length

The total length L of the sensor is specified by appending "Lxxx" to the type.

xxx: Length in cm

Preferred lengths

500 mm: L050

1100 mm: L110

ID-No.

P21197050

P21197110

Housing material

Aluminium

Material

AISI 316 Ti

Sealing material

NBR, different material on request

Compressive strength [bar]

6 (25 $^{\circ}\text{C}$)

Connection

M12 connector

* Depending on the medium, deviations from the specified measuring accuracy can occur in this area.

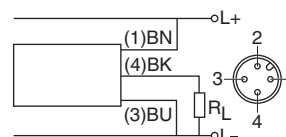

Accessories

connecting cable SLG / SLW 3..., see page 2.45



Microwave-Compact

Series MFC
G3/4 thread

DC 16...30 V

Sensor length up to 1000 mm

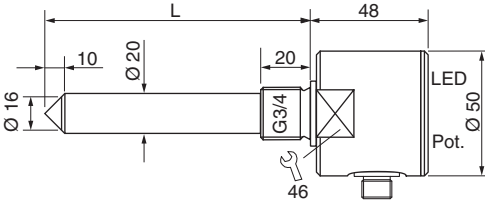

Design	DC PNP • G3/4	
Dimensions		
Switching point sp	[mm]	-6
Switching output		
ID-No.	P21188...	
Type-sensor length L	MFC 075 GSP-Lxxx	
Supply voltage	[V]	16...30 DC
Switching current	[mA]	200
Short circuit proof		•
Overcurrent release	[mA]	250
Reverse protection		•
Voltage drop	[V]	2
Current consumption	[mA]	50
Switching frequency	[Hz]	approx. 5
Ambient temperature	[°C]	-20...+85
Sensitivity*	[ε _r]	pre-selectable
Protection	[EN 60529]	IP 67
LED display		•
Housing material	AISI 316 Ti / PTFE	
Sealing material	NBR, different materials on request	
Compressive strength	[bar]	16 (25 °C)
Connection	M12 connector	
Accessories	connecting cable SLG 3..., SLW 3..., see page 2.45	

Sensor length

The total length L of the sensors is specified by appending "Lxxx" to the type.

xxx: length in mm

Preferred excess lengths	ID-No.
120 mm: L120	P21188012
200 mm: L200	P21188020
400 mm: L400	P21188040

Adjustment note ε_r:
Remove the protection screw. By pressing the button with the screwdriver provided, you can adjust the sensitivity.

*Sensitivity	
○	green : ε _r ≥60
○○	green : ε _r ≥25
○○○	green : ε _r ≥4
○○○○	green : ε _r ≥1,7

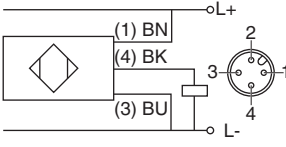



Microwave-Compact

Series MFK
G1/2 thread

DC 16...30 V

Sensor length 40 mm

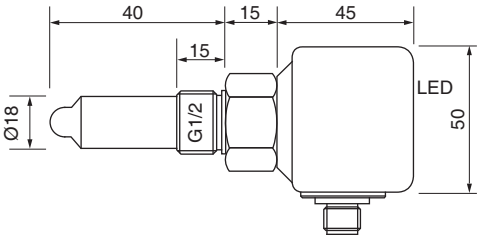

Design	DC PNP • G1/2
Dimensions	
Switching point sp [mm]	-6
Switching output	
ID-No.	P21193
Type	MFK 50 GSP
Supply voltage [V]	16...30 DC
Switching current [mA]	200
Short circuit proof	•
Overcurrent release [mA]	250
Reverse protection	•
Voltage drop [V]	2
Current consumption [mA]	40
Switching frequency [Hz]	approx. 5
Ambient temperature [°C]	-20...+85
Sensitivity [εr]	> 10
Protection [EN 60529]	IP 67
LED display	•
Housing material	PBT / AISI 316 Ti / PTFE
Sealing material	NBR, different materials on request
Compressive strength [bar]	16 (25 °C)
Connection	M12 connector

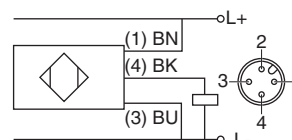



Accessories connecting cable SLG 3..., SLW 3..., see page 2.45

Capacitive sensor-compact

Series KGF
PTFE housing
M14x1
M30x1.5

AC 20...250 V
DC 10...55 V

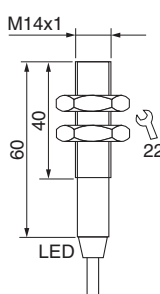
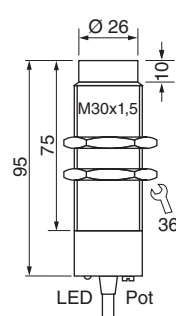
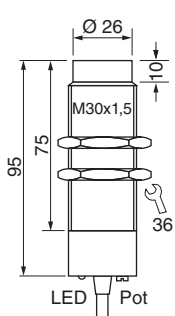

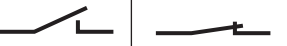
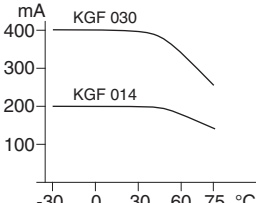
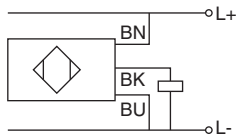
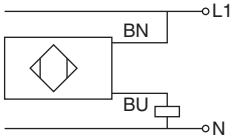
Design	DC PNP • M14x1		DC PNP • M30x1.5		AC • M30x1.5	
Dimensions						
Switching point sp [mm]	-2	-2	-3	-3	-3	-3
Switching output						
Best.-Nr.	P20130	P21106	P20051	P20052	P20002	P20003
Type	KGF 014 GSP	KGF 014 GOP	KGF 030 GSP	KGF 030 GOP	KGF 030 WS	KGF 030 WO
Supply voltage [V]	10...33 DC		10...55 DC		20...250 AC	
Switching current [mA]	200		400		400	
Short circuit proof	•		•		-	
Overcurrent release [mA]	800		800		-	
Reverse protection	•		•		-	
Voltage drop [V]	1 DC		1 DC		8 AC	
Minimum load current [mA]	-		-		5	
Current consumption [mA]	4		4		2.5	
Switching frequency [Hz]	10		10		10	
Ambient temperature [°C]	-25...+75		-25...+75		-25...+75	
EMC-class	A		A		A	
Protection [EN 60529]	IP 67		IP 67		IP 67	
LED display	•		•		•	
Housing material	PTFE		PTFE		PTFE	
Connection	2 m PVC-cable 3x0.34 mm ²		2 m PVC-cable 0.5 mm ²		2 m PVC-cable 0.5 mm ²	
Switching current						
Accessories	fixing nuts are part of delivery					

Capacitive sensor-compact

Series **KGF/KGMR**
G3/4 thread

AC 20...250 V
DC 10...55 V



Design	AC • G3/4		DC PNP • G3/4		DC PNP • G3/4
Dimensions					
Switching point sp	-2		-2		-3
Switching output					
ID-No.	P20005		P20006		P21101
Type	KGF 075 WS		KGF 075 WO		KGMR 107 GSP
Supply voltage [V]	20...250 AC		10...55 DC		10...55 DC
Switching current [mA]	400		400		300
Short circuit proof	-		•		•
Overcurrent release [mA]	-		800		800
Reverse protection	-		•		•
Voltage drop [V]	8 AC		1 DC		1.5 DC
Minimum load current [mA]	5		-		-
Current consumption [mA]	2.5		4		4
Switching frequency [Hz]	10		10		10
Ambient temperature [°C]	-25...+75		-25...+75		-25...+75
EMC-class	A		A		A
Protection [EN 60529]	IP 67		IP 67		IP 67
LED display	•		•		•
Housing material	PTFE		PTFE		PTFE / AISI 316 Ti
Sealing material	-		-		FPM
Connection	2 m PVC-cable 0.5 mm ²				
Switching current					

Capacitive sensor-compact

Series **KGFR**
PTFE housing
G1 thread

AC 20...250 V
DC 10...55 V



Design	AC • G1		DC PNP • G1			
Dimensions						
Switching point sp	[mm]	-6	-6	-6	-6	
Switching output						
ID-No.		P20009	P20010	P20063	P20064	P21198
Type		KGFR 100 WS	KGFR 100 WO	KGFR 100 GSP	KGFR 100 GOP	KGFR 100 GSOP
Supply voltage	[V]	20...250 AC		10...55 DC	10...55 DC	10...30 DC
Switching current	[mA]	400		400	400	200
Short circuit proof		-		•	•	•
Overcurrent release	[mA]	-		800	800	450
Reverse protection		-		•	•	•
Voltage drop	[V]	8 AC		1 DC	1 DC	1.5 DC
Minimum load current	[mA]	5		-	-	-
Current consumption	[mA]	2.5		4	4	10
Switching frequency	[Hz]	10		10		
Ambient temperature	[°C]	-25...+75		-25...+75		
EMC-class		A		A		
Protection	[EN 60529]	IP 67		IP 67		
LED display		•		•		
Housing material		PTFE		PTFE		
Connection		2 m PVC-cable 0.5 mm ²		GSP/GOP: 2 m PVC-cable 0.5 mm ² GSOP: 2 m PVC-cable 0.34 mm ²		
Switching current						

Capacitive sensor-compact

Series KA
G1 thread

DC 10...55 V



Design	DC PNP • G1 • L=45 mm	DC PNP • G1 • L=120 mm
Dimensions		
Switching point sp [mm]	-8	-8
Switching output		
ID-No.	P21010	P21011
Type-sensor length L	KA-L45-GPP	KA-L120-GPP
Supply voltage [V]	10...55 DC	
Switching current [mA]	400	
Short circuit proof	•	
Overcurrent release [mA]	800	
Reverse protection	•	
Voltage drop [V]	2	
Minimum load current [mA]	-	
Current consumption [mA]	4	
Switching frequency [Hz]	5	
Ambient temperature [°C]	housing: -25...+70 / sensor tip: -25...+120	
EMC-class	A	
Protection [EN 60529]	IP 67	
LED display	•	
Housing material	PTFE / AISI 316 Ti	
Sealing material	FPM	
Compressive strength [bar]	30 (25 °C)	
Connection	terminal screws	
Switching current		

Capacitive sensor-compact

Series KB
G1 thread

DC 10...55 V



Design

DC PNP • G1

Dimensions

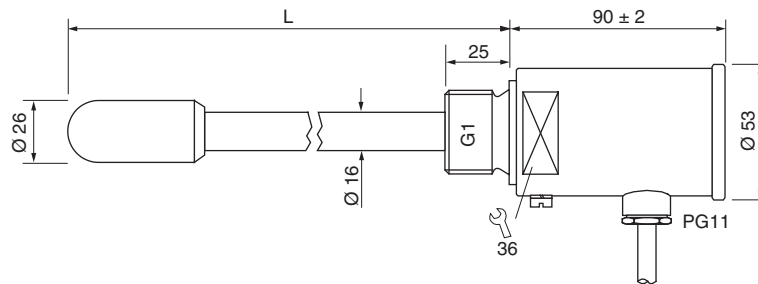

Switching point sp [mm]	-8			
Switching output				
ID-No.	P21012	P21013	P21014	P21015
Type-sensor length L	KB-L200-GPP	KB-L400-GPP	KB-L600-GPP	KB-L1000-GPP
Supply voltage [V]	10...55 DC			
Switching current [mA]	400			
Short circuit proof	•			
Overcurrent release [mA]	800			
Reverse protection	•			
Voltage drop [V]	2			
Minimum load current [mA]	-			
Current consumption [mA]	4			
Switching frequency [Hz]	5			
Ambient temperature [°C]	housing: -25...+70 / sensor tip: -25...+120			
EMC-class	A			
Protection [EN 60529]	IP 67			
LED display	•			
Housing material	PTFE / AISI 316 Ti			
Sealing material	FPM			
Compressive strength [bar]	16 (25 °C)			
Connection	terminal screws			

Switching current

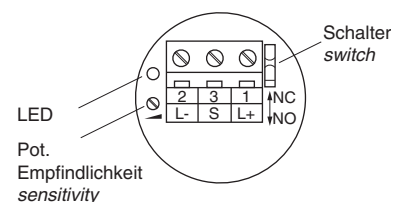
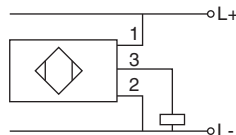
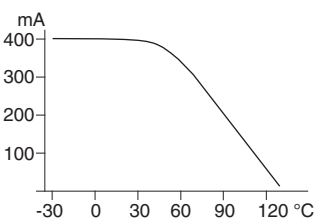

Capacitive sensor-compact

Series KFC
G1/2 thread

DC 18...33 V

Stainless steel housing

PTFE-sensor



Design DC PNP • G1/2

Dimensions

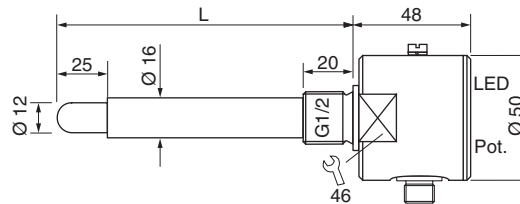

Switching point sp [mm]	-6			
Switching output				
ID-No.	P21161	P21162	P21163	P21164
Type-sensor length L	KFC 050 GSP-L50	KFC 050 GSP-L100	KFC 050 GSP-L200	KFC 050 GSP-L400
Supply voltage [V]	18...33 DC			
Switching current [mA]	200			
Short circuit proof	•			
Overcurrent release [mA]	250			
Reverse protection	•			
Voltage drop [V]	2			
Minimum load current [mA]	-			
Current consumption [mA]	10			
Switching frequency [Hz]	5			
Ambient temperature [°C]	housing: -25...+75 / sensor tip: -25...+120			
EMC-class	A			
Protection [EN 60529]	IP 67			
LED display	•			
Housing material	AISI 316 Ti / PTFE			
Sealing material	FFKM (Kalrez)			
Compressive strength [bar]	16 (25 °C)			
Connection	M12 connector			
Switching current				

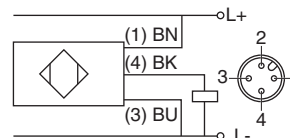
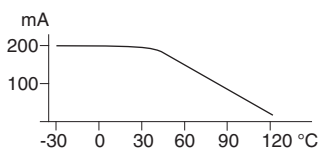

Accessories connecting cable type SLG 3..., SLW 3..., see page 2.45

Opto switch-compact

Series UFGS
Opto glass-sensor
G3/4 thread

DC 10...33 V

Resistant to detergents
Resistant to hydraulic oil • motor oil



Design

DC PNP • G3/4

Dimensions

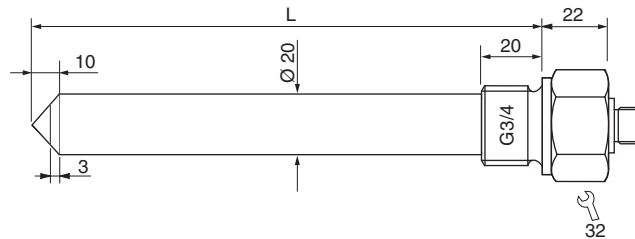

Switching point sp [mm]	-10	
Switching output		
ID-No.	P21181...	
Type-sensor length L [mm]	UFGS 075 GSOP-Lxxxx	Sensor length
Supply voltage [V]	10...33 DC	The total length L of the sensors is specified by appending "Lxxxx" to the type.
Switching current [mA]	200	xxxx: length in mm
Short circuit proof	•	
Overcurrent release [mA]	250	
Reverse protection	•	
Voltage drop [V]	2	
Minimum load current [mA]	-	
Current consumption [mA]	10	Preferred excess lengths
Switching frequency [Hz]	5	120 mm: L120
Ambient temperature [°C]	-25...+70	200 mm: L200
EMC-class	A	400 mm: L400
Protection [EN 60529]	IP 67	600 mm: L600
LED display	plug with LED	1000 mm: L1000
Housing material	AISI 316 Ti/glass	ID-No.
Sealing material	FFKM (Kalrez)	120 mm: L120
Compressive strength [bar]	16 (25 °C)	200 mm: L200
Connection	M12 connector	400 mm: L400
Switching current		600 mm: L600
		1000 mm: L1000

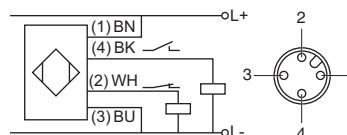
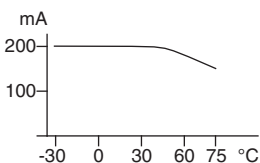

Accessories

connecting cable type SLW 4-2 LED (Z01157), see page 2.45

Opto switch-compact

Series UFS
G3/4 thread

DC 10...33 V

Plug connection



Design DC PNP • G3/4

Dimensions

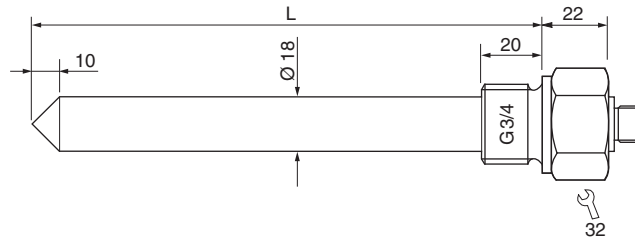

Switching point sp [mm]	-10	
Switching output		
ID-No.	P....	
Type-sensor length L [mm]	UFS 075 GSOP-Lxxxx	Sensor length
Supply voltage [V]	10...33 DC	The total length L of the sensors is specified by appending "Lxxxx" to the type.
Switching current [mA]	200	xxxx: length in mm
Short circuit proof	•	
Overcurrent release [mA]	250	
Reverse protection	•	
Voltage drop [V]	2	
Minimum load current [mA]	-	
Current consumption [mA]	10	Preferred excess lengths
Switching frequency [Hz]	5	60 mm: L060
Ambient temperature [°C]	-25...+70	100 mm: L100
EMC-class	A	200 mm: L200
Protection [EN 60529]	IP 67	400 mm: L400
LED display	plug with LED	600 mm: L600
Housing material	AISI 316 Ti / PES	1000 mm: L1000
Sealing material	FPM	
Compressive strength [bar]	16 (25 °C)	
Connection	M12 connector	
Switching current		

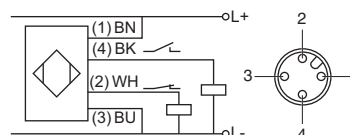
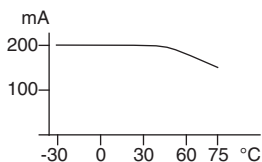

Accessories connecting cable type SLW 4-2 LED (Z01157), see page 2.45

Conductive compact model

Series CFC

Exact level monitoring of conductive media



Design

DC PNP • G1/2

Dimensions

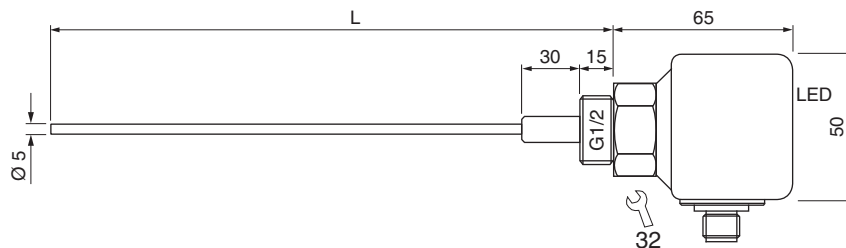

Conductivity [µS/cm]	> 10 (adjustable)
Sensor length typ. [mm]	300 / 500 / 1000 *
Switching output	
ID-No.	P.....
Type-sensor length L [mm]	CFC 050 GSOP-Lxxxx
Supply voltage [V]	24 DC ±20%
Switching current [mA]	100
Short circuit proof	•
Overcurrent release [mA]	150
Reverse protection	•
Voltage drop [V]	2,5
Current consumption [mA]	50
Ambient temperature [°C]	-20...+60
EMC-class	A
Protection [EN 60529]	IP 67
LED display	•
Housing material	AISI 316 Ti / PBT / POM
Sealing material	EPDM, different material on request
Compressive strength [bar]	6 (25 °C)
Connection	M12 connector

Sensor length

The total length L of the sensors is specified by appending "Lxxxx" to the type.

xxxx: length in mm

Preferred lengths	ID-No.
300 mm: L300	P21211
500 mm: L500	P21212
1000 mm: L1000	P21213

Notes:

Different lengths:
Please note in ordering text.
In applications with plastic containers the screw-on-electrode has to be used.

* Cutting to length by user:
See technical manual

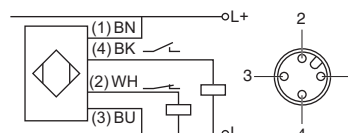

Accessories

screw-on-electrode, see page 2.46 / connecting cable SLG 4..., SLW 4..., see page 2.45

Hydrostatic level meter

Series DGC 075

Analog output



Design

DC • G3/4

Dimensions

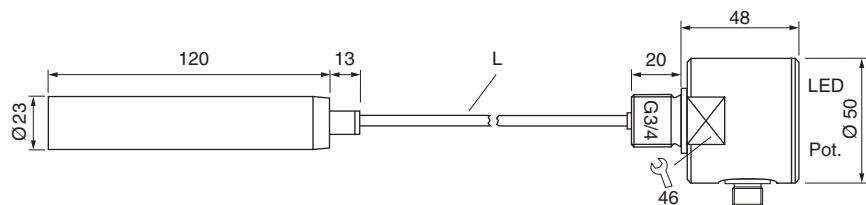

Depth of immersion [cm]	see sensor length	Sensor length The total length L of the sensor is specified by appending "Lxxx" to the type. xxx: length in cm												
Output	 4...20 mA													
ID-No.	P.....	Preferred lengths <table border="1"> <thead> <tr> <th>Preferred lengths</th> <th>ID-No.</th> </tr> </thead> <tbody> <tr> <td>100 cm: L100</td> <td>P21224</td> </tr> <tr> <td>150 cm: L150</td> <td>P21225</td> </tr> <tr> <td>200 cm: L200</td> <td>P21226</td> </tr> <tr> <td>250 cm: L250</td> <td>P21227</td> </tr> <tr> <td>300 cm: L300</td> <td>P21228</td> </tr> </tbody> </table>	Preferred lengths	ID-No.	100 cm: L100	P21224	150 cm: L150	P21225	200 cm: L200	P21226	250 cm: L250	P21227	300 cm: L300	P21228
Preferred lengths	ID-No.													
100 cm: L100	P21224													
150 cm: L150	P21225													
200 cm: L200	P21226													
250 cm: L250	P21227													
300 cm: L300	P21228													
Type	DGC 075 GI-Lxxx													
Supply voltage [V]	24 DC ±10%													
Load resistance R_L [Ω]	200...500													
Current consumption [mA]	< 30													
Ambient temperature [$^{\circ}\text{C}$]	-20...+75													
Medium temperature [$^{\circ}\text{C}$]	-20...+75													
Compressive strength sensor unit [bar]	2													
Material sensor	AISI 316 Ti													
Material measuring cell	Ceramic													
Material cable sheath	PUR													
Sealing material	FPM													
Protection [EN 60529]	housing: IP 65 / probe: IP 68													
Connection	M12 connector													

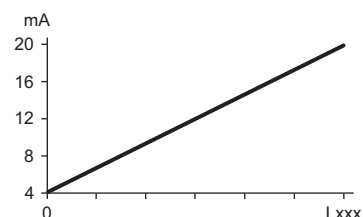
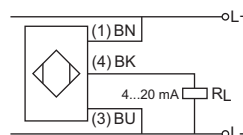
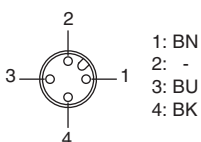

Accessories



connecting cable type SLG 3-2 (Z01076), see page 2.45

Capacitive analog sensor

Series KFA
up to 200 °C

4...20 mA
output

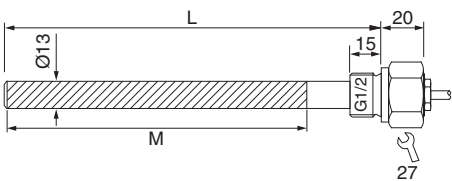
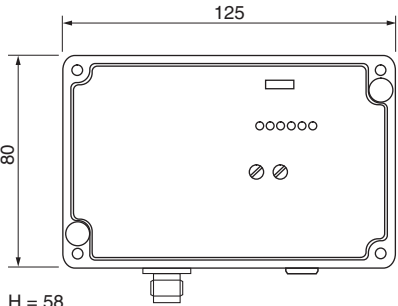

Design	G1/2		KU 120 GI
Dimensions			
Sensing length M [mm]	100	200	
Output	-	-	
ID-No.	P21151	P21152	P21153
Type-sensor length L	KFA 150-L135	KFA 150-L235	KU 120GI
Supply voltage [V]	-	-	24 DC ±20%
Current output [mA]	-	-	4...20
Current consumption [mA]	-	-	50
Working resistance [Ω]	-	-	50...400
Reaction frequency [Hz]	-	2	5
Ambient temperature [°C]	-	-35...+200	-20...+60
EMC-class	-	A	A
Protection [EN 60529]	-	IP 68	IP 65
LEM-connection	-	IP 54	IP 54
LED display	-	-	•
Housing material	-	PKS/AISI 316 Ti	Aluminium
Sealing material	-	PTFE	-
Compressive strength [bar]	-	16	-
Connection	2 m PTFE-cable / LEM 01 plug system		M12 connector

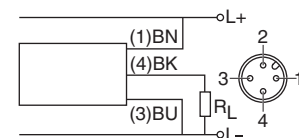
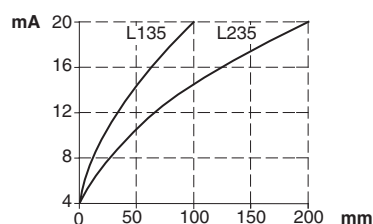

Accessories

connecting cable SLG 3-2, see page 2.45

Capacitive –230 °C-Low temperature

Series KGFP

Detection of liquid gases
Detection of cooled granules

Sensor for connection to an external amplifier



Design	G1/2		KU 125...
Dimensions			
Switching point sp	adjustable	adjustable	adjustable
Switching output			
ID-No.	P21167	P21196	P21166
Type	KGFP 050	KGFP 051	KU 125 GPP
Application area	liquid gases	cooled granules	
Medium temperature [°C]		-230...+80	-
Cable temperature [°C]		-80...+120	-
Supply voltage [V]		-	24 DC ±20%
Current consumption [mA]		-	50
Switching current [mA]		-	400
Hysteresis [%]		-	10 (adjustable)
Switching frequency [Hz]		-	10
Ambient temperature [°C]		-	-20...+60
EMC-class		-	A
Protection [EN 60529]			
housing		IP 68	IP 65
plug		IP 67	IP 67
LED display		-	•
Power on LED		-	•
Housing material		AISI 316 Ti/PTFE	Aluminium
Connection		2 m PTFE-cable with LEM 02 plug system	M12 connector

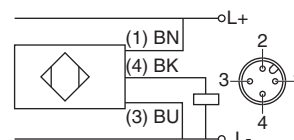

Accessories

connecting cable type SLG 3..., SLW 3..., see page 2.45

Capacitive 230 °C-High temperature

Series KGFT

Sensor for connection to an external amplifier

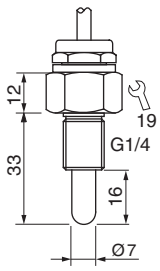
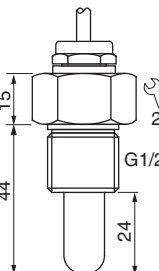
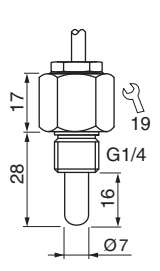
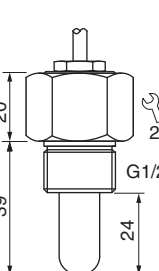
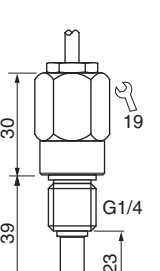
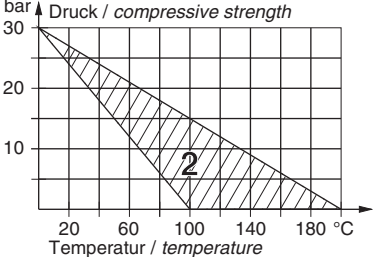

Design	G1/4	G1/2	G1/4	G1/2	G1/4
Dimensions					
Switching point sp [mm]	-6	-6	-6	-6	-6
ID-No.	P21092	P21093	P21119	P21120	P21108
Type	KGFT 025	KGFT 050	KGFT 125	KGFT 150	KGFT 325
Temperature range [°C]	-35...+180	-35...+180	-35...+200	-35...+200	-35...+230
Protection [EN 60529]					
sensor	IP 68	IP 68	IP 68	IP 68	IP 68
plug LEM 01	IP 54	IP 54	IP 54	IP 54	IP 54
Compressive strength [bar]	10	10	30	30	0.5
Housing material	PTFE / AISI 316 Ti	PTFE / AISI 316 Ti	PEEK / AISI 316 Ti	PEEK / AISI 316 Ti	PEEK / AISI 316 Ti
Sealing material	FPM	FPM	PTFE	PTFE	EP
Connection	2 m PTFE-cable with LEM 01 plug system				
	<p>For special applications the seal must be determined separately. In such cases, the combination of pressure and temperature is of great importance (see diagram). Special EPDM seals will be used on customers request for water applications up to +150 °C and pressure up to 5 bar. Special seals are necessary for applications with media temperatures above +100 °C or where pressures are higher (2).</p>				
If water damp phases cannot be excluded, the KGFT...-CER sensor must be used. (see page 2.29)					
Required amplifiers:	KK 030 GSP , KU 120..., KUA 120..., see page 2.30 - 2.31				

Capacitive 200 °C-High temperature

Series KGFT-CER

Steam proof

Sensor for connection
to an external amplifier

30 bar at 140 °C
15 bar at 200 °C



Design	G1/4	KK 030...
Dimensions		
Switching point sp	-6	adjustable
Switching output		
ID-No.	P21199	P21095
Type	KGFT 125-CER	KK 030 GSP
Supply voltage [V]	-	16...55 DC
Current consumption [mA]	-	15
Switching current max. [mA]	-	200
Hysteresis [%]	-	10
Switching frequency [Hz]	-	15
Ambient temperature [°C]	-35...+200	-5...+60
EMC-class	-	A
Protection [EN 60529]	IP 68 (plug LEM 01 IP 54)	IP 67 (plug LEM 01 IP 54)
Compressive strength [bar]	30 at 140 °C / 15 at 200 °C	-
LED display	-	LED yellow
Power on LED	-	LED green
Housing material	AISI 316 Ti / Ceramic	AISI 316 Ti
Sealing material	PTFE	-
Sensor connection	-	LEM 01 plug system
Connection	2 m PTFE-cable with LEM 01 plug system	M12 connector

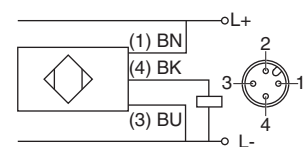
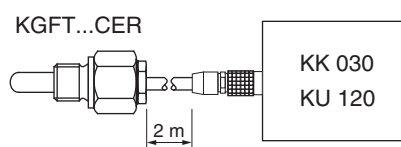
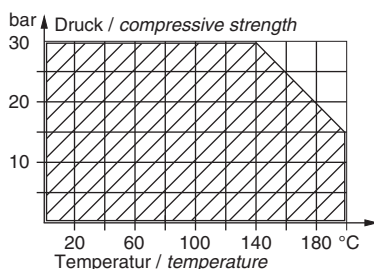

Accessories

connecting cable SLG 3..., SLW 3..., see page 2.45

Capacitive amplifiers

Series KK/KU

For sensors KGFT
up to +230 °C

IP 67 Protection

LED display



Design	KK 030...	KU 120...		
Dimensions				
Switching point sp	adjustable	adjustable		
Switching output				
ID-No.	P21095	P21107	P21118	P21117
Type	KK 030 GSP	KU 120 GPP-24	KU 120 WP-230	KU 120 WP-115
Supply voltage [V]	16...55 DC	24 DC ±20%	230 AC ±10%	115 AC ±10%
Current consumption [mA]	15		50	
Switching current max. [mA]	200		400	
Hysteresis [%]	10		10 (adjustable)	
Switching frequency [Hz]	15		5	
Ambient temperature [°C]	-5...+60		-20...+60	
EMC-class	A		A	
Protection [EN 60529]	IP 67		IP 65	
LEM-Connection	IP 54		IP 54	
LED display	LED yellow		LED-array	
Power on LED	LED green		•	
Housing material	AISI 316 Ti		Aluminium	
Sensor Connection	LEM 01 plug		LEM 01 plug	
Connection	M12 connector	M12 connector	2 m PVC-cable 4x0.75 mm ²	
Accessories	connecting cable type SLG 3..., SLW 3..., see page 2.45			

Capacitive amplifier

Series KUA

Automatic adjustment on medium

For sensors KGFT up to +230 °C

Cable break monitoring

LED display



Design	KUA 120 GSOP
Dimensions	
Switching point sp	automatic adjustment by push-button or control input
Switching output	
ID-No.	P21190
Type	KUA 120 GSOP
Supply voltage [V]	18...30 DC
Current consumption [mA]	approx. 100
Switching current max. [mA]	100
Hysteresis [%]	10
Switching frequency [Hz]	10
Ambient temperature [°C]	0...+60
EMC-class	A
Protection [EN 60529]	IP 65
LEM-Connection	IP 54
LED display	LED-array
Cable break monitoring	•
Housing material	Aluminium
Sensor Connection	LEM 01 plug
Connection	M12 connector
	The capacitive amplifier is designed to be connected to the level controller of type KGFT... The adjustment depending on different media or installation situations is carried out by automatic adjustment.

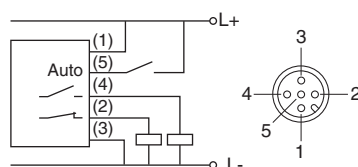

	unbetätigt	betätigt	Kabelbruch
LED-Zeile	●○○○○○	○●●○○○	●●●●●●
Schaltausgang Schliesser			
Schaltausgang Öffner			

Accessories connecting cable type SLG 5..., SLW 5..., see page 2.45

Dust - Intrinsically safe • Zone 20

Series **KGEX**
Capacitive sensors

Category 1
Dust II 1D T95 °C

Proximity switches
Level controller



Design	M18x1	M30x1.5	G1	G3/4
Dimensions				
Installation flush (f) non flush (nf)				
Operating distance sn [mm]	8 nf	10 nf	-10	-5
ID-No.	P21157	P21158	P21159	P21160
Type	KGEX 018	KGEX 030	KGEX 100	KGEX 107
Ambient temperature [°C]	-25...+75			
Ex marking	II 1D T95 °C			
Certificate No.	TÜV 03 ATEX 2046			
Maximum values	Ci = negligibly small Li = negligibly small			
Only for the connection to certified intrinsically safe circuits with the following maximum values:	Ii = 80 mA Ui = 12.6 V Pi = 252 mW			
Housing material	PVDF	PTFE	PTFE	PTFE / AISI 316 Ti FPM
Protection [EN 60529]	IP 67			
Connection	2 m PVC-cable 3x0.5 mm ²			
For the connection to amplifiers IKM 123 Ex-..., page 2.40				
Note	fixing nuts are part of delivery			

Dust - Compact model • Zone 22

Series **KGEX**
Capacitive sensors

Category 3
Dust II 3D T80 °C

DC 24 V
PNP switching output



Design	M18x1	M30x1.5	DC PNP • G1	DC PNP • G3/4
Dimensions				
Installation flush (f) non flush (nf)				
Switching point sp [mm] (Adjustable)	5 f (1...7)	10 f (3...15)	-6	-3
Switching output				
ID-No.	P21170	P21171	P21172	P21173
Type	KGEX 018 GSP	KGEX 030 GSP	KGEX 100 GSP	KGEX 107 GSP
Ex-Marking	II 3D T 80 °C			
Supply voltage [V]	10...55 DC			
Switching current [mA]	300			
Short circuit proof	•			
Overcurrent release [mA]	800			
Reverse protection	•			
Voltage drop max. [V]	1.5			
Current consumption [mA]	4			
Switching frequency [Hz]	25	25	10	10
Ambient temperature [°C]	-25...+70			
EMC-class	A			
LED display	•			
Housing material	Br-Ni / PPO	Br-Ni / PPO	PTFE	PTFE / AISI 316 Ti FPM
Protection [EN 60529]	IP 67			
Connection	2 m PVC-cable 3x0.5 mm ²			
Note: Do not use in the presence of conductive dusts				

Ex - Sensor • Zone 0

Series **UFGS..Ex**
Opto glass-sensor

Category 1
Ex II 1G Ex ia IIC T6...T4

Resistant in kerosine • motor fuels

3-wire sensor, intrinsically safe



Design	G3/4									
Dimensions										
Switching point sp [mm]	-10									
ID-No.	P21183...	<p>Sensor length</p> <p>The total length L of the sensors is specified by appending "Lxxxx" to the type.</p> <p>xxxx: length in mm</p> <p>Preferred excess lengths ID-No.</p> <table border="0"> <tr> <td>120 mm: L120</td> <td>P21183012</td> </tr> <tr> <td>200 mm: L200</td> <td>P21183020</td> </tr> <tr> <td>400 mm: L400</td> <td>P21183040</td> </tr> <tr> <td>1000 mm: L1000</td> <td>P21183100</td> </tr> </table>	120 mm: L120	P21183012	200 mm: L200	P21183020	400 mm: L400	P21183040	1000 mm: L1000	P21183100
120 mm: L120	P21183012									
200 mm: L200	P21183020									
400 mm: L400	P21183040									
1000 mm: L1000	P21183100									
Type-sensor length L [mm]	UFGS 075 Ex-Lxxxx									
Ex marking	II 1G Ex ia IIC T6...T4									
Certificate no.	TÜV 01 ATEX 1662									
Ambient temperature for temperature classes [°C]	T6: 75 T5: 90 T4: 100									
Max. power Pi [mW]	252									
Housing material	AISI 316 Ti / glass									
Sealing material	FFKM (Kalrez)									
Tightening torque [Nm]	100									
Ambient temperature [°C]	-25...+70									
Protection [EN 60529]	IP 67									
Compressive strength [bar]	16									
Connection	M12 connector									

For the connection to amplifiers IKM 123 Ex-..., page 2.40

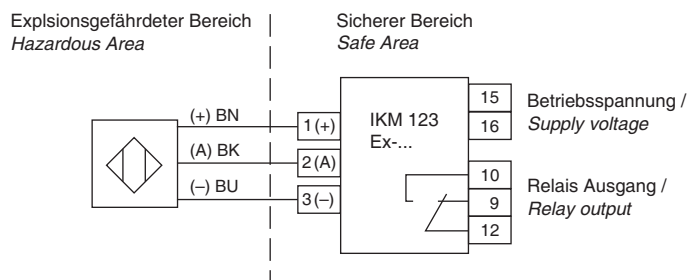
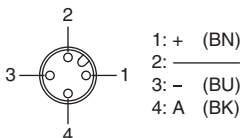

Accessories plug M12, SBG-DC (Z01060) oder SBW-DC (Z00038)

Ex - Sensor • Zone 0

Series URFG..Ex
Opto glass-sensor
For fuel tanks and fuel trucks

Category 1
Ex II 1G Ex ia IIC T6...T4

Resistant in kerosine • motor fuels

2-wire sensor, intrinsically safe



Design	G3/4									
Dimensions										
Switching point sp [mm]	-10									
ID-No.	P21185...	<p>Sensor length</p> <p>The total length L of the sensors is specified by appending "Lxxxx" to the type.</p> <p>xxxx: length in mm</p> <p>Preferred excess lengths ID-No.</p> <table> <tr> <td>120 mm: L120</td> <td>P21185012</td> </tr> <tr> <td>200 mm: L200</td> <td>P21185020</td> </tr> <tr> <td>400 mm: L400</td> <td>P21185040</td> </tr> <tr> <td>1000 mm: L1000</td> <td>P21185100</td> </tr> </table>	120 mm: L120	P21185012	200 mm: L200	P21185020	400 mm: L400	P21185040	1000 mm: L1000	P21185100
120 mm: L120	P21185012									
200 mm: L200	P21185020									
400 mm: L400	P21185040									
1000 mm: L1000	P21185100									
Type-sensor length L [mm]	URFG 075 Ex-Lxxxx									
Ex marking	II 1G Ex ia IIC T6									
Certificate no.	TÜV 00 ATEX 1632									
Ambient temperatur for temperature classes [°C]	T6: 70 T5: 80 T4: 100									
Maximum values	li = 154 mA Ui = 23.1 V Pi = 890 mW									
Housing material	AISI 316 Ti / glass									
Sealing material	FFKM (Kalrez)									
Tightening torque [Nm]	100									
Ambient temperature [°C]	-25...+70									
Protection [EN 60529]	IP 67									
Compressive strength [bar]	16									
Connection	M12 connector									
For the connection to amplifiers SF3, page 2.41	<p>Explosionsgefährdeter Bereich Sicherer Bereich Hazardous Area Safe Area</p> <p>(+) BN — L+ — BN Betriebsspannung / Supply voltage (-) BU — L- — BU NO — BK Relais Ausgang / Relay output NC — BU C — BN</p>									
Accessories	plug M12, SBG-DC (Z01060) oder SBW-DC (Z00038)									

Ex - Sensor • Zone 0 - 1

Series TF...Ex
Thermal level sensor
For fuel tanks and fuel trucks

Category 1, Category 2
 Ex II 1G Ex ia IIC T4 (pipe AISI 316 Ti)
 Ex II 2G Ex ia IIC T4 (pipe aluminium)

2-wire sensor, intrinsically safe



Design	G3/4 fixed fitting length		G3/4 adjustable fitting length	
Dimensions				
Switching point sp [mm]	10 immersed			
Type	TFGS 026 Ex-L200	TFGS 126 Ex-L200	TFKS 026 Ex-L400	TFKS 126 Ex-L400
ID-No.	P21191	P21194	P21192	P21195
Fitting length L [mm]	210	210	410 (variable)	410 (variable)
Zone	0	1	0	1
Ex marking	II 1G Ex ia IIC T4	II 2G Ex ia IIC T4	II 1G Ex ia IIC T4	II 2G Ex ia IIC T4
Certificate No.	TÜV 07 ATEX 553745			
Maximum values	li = 154 mA / Ui = 23,1 V / Pi = 890 mW / Ci ≤ 100 pF / Li ≤ 0,8			
Nominal resistance [Ω]	160			
Reaction time [s]	approx. 2			
Start-up time [s]	40			
Ambient temperature [°C]	-20...+80			
Function indicator	at the amplifier			
Housing material	AISI 316 Ti	AISI 316 Ti	AISI 316 Ti	AISI 316 Ti
Pipe material	AISI 316 Ti	Aluminium	AISI 316 Ti	Aluminium
Sealing material	PVDF, FPM			
Protection [EN 60529]	IP 68			
Connection	M12 connector			
Sensors for the connection to amplifiers SF3, page 2.41				
Accessories	plug M12, SBG-DC (Z01060) oder SBW-DC (Z00038)			

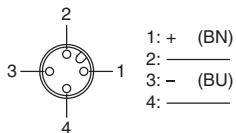

Ex - Sensor • Zone 0

Series KEAC
Capacitive sensors

Category 1
Ex ia IIC T6...T4

Medium up to 120 °C
Sensor length up to 1 m



Design	G1				
Dimensions					
Sensitivity adjustable					
Switching point sp [mm]	-8	-8	-8	-8	-8
ID-No.	P21086	P21087	P21088	P21089	P21090
Type-sensor length L [mm]	KEAC-L80	KEAC-L200	KEAC-L400	KEAC-L600	KEAC-L1000
Ex marking	Ex ia IIC T6...T4				
Certificate no.	TÜV 96 ATEX 1095				
Ambient temperature for temperature classes [°C]	T6: 80 T5: 95 T4: 120				
Max. power Pi [mW]	50				
Housing material	AISI 316 Ti / PTFE				
Sealing material	FPM				
Force thread [Nm]	100				
Sensitivity	adjustable with pot				
Ambient temperature [°C]	housing: -25...+75 / sensor tip: -40...+120				
Protection [EN 60529]	IP 67				
Compressive strength [bar]	30				
Connection	terminal screws				
For the connection to amplifiers IKM 122 Ex-..., page 2.39					
Note	different materials on request				

Ex - Sensor • Zone 0 • with Ex-Preamplifier

Series KGFT
Capacitive sensors
up to 200 °C

Category 1

Ex ia T6...T3

Ex II (1) 2G Ex ia IIC T6...T4



Design	G1/4	G1/2	KK 030 Ex
Dimensions			
Switching point sp [mm]	-8	-8	-
Sensitivity adjustable	-	-	•
ID-No.	P21149	P21150	P21144
Type	KGFT 125 Ex	KGFT 150 Ex	KK 030 Ex
Ex marking	Ex ia IIC T6...T3		II (1) 2G Ex ia IIC T6...T4
Certificate No.	TÜV 01 ATEX 1670		TÜV 01 ATEX 1671
Ambient temperatures for temperature classes [°C]	T6: 80 T5: 95 T4: 130 T3: 195		T6: 75 T5: 90 T4: 120
Max. power Pi [mW]	110		252
Housing material	AISI 316 Ti / PEEK		AISI 316 Ti
Sealing material	PTFE		-
Torque [Nm]	50	100	50
Ambient temperature [°C]	-35...+200		-25...+60
Protection [EN 60529]	Sensor: IP 68 / LEM-connection: IP 54		IP 54
Compressive strength [bar]	30		-
LED display	-		•
Connection	2 m PTFE-cable plug system LEM 01		LEM 01 / M12 connector

The KK 030 Ex ex-preamplifier is operated in zone 1. It is connected between the KGFT...Ex ex-sensors and the IKM 123 Ex.. ex-amplifier (see page 2.40).

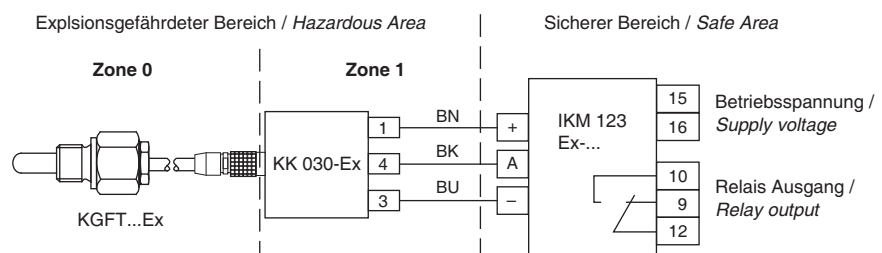

Accessories required amplifier IKM 123 Ex-..., see page 2.40 / connecting cable SLG 3..., SLW 3..., see page 2.45

- Amplifiers

Series IKM 122 Ex

Gas II (1) G [Ex ia Ga] IIC

Dust II (1) D [Ex ia Da] IIIC

Cable break and short circuit monitoring

Connection to intrinsically safe 2-lead sensors

Output function programmable



Design	IKM 122 Ex...	
Dimensions		
ID-No.	P31332	P31333
Type	IKM 122 Ex-230	IKM 122 Ex-24
Output	 relay / change over	
Ex area of use	outside of the hazardous areas (gas or dust)	
Certificate No.	TÜV 11 ATEX 556280	
Ex marking	Gas: II (1) G [Ex ia Ga] IIC	Dust: II (1) D [Ex ia Da] IIIC
Ambient temperature [°C]	-20 ≤ Ta ≤ +60	
Maximum values	U _o = 9.6 V / I _o = 10.1 mA / P _o = 24.2 mW / C _o = 0.84 μF / L _o = 5.00 mH	
Supply voltage [V]	230 AC ±10%	24 DC ±10%
Switching voltage max [V]	250 AC / 60 DC / 24 DC	
Switching current max. [A]	4 AC / 0.8 DC / 4 DC	
Switching power	cos φ > 0.7 / L/R ≤ 200 ms / L/R ≤ 200 ms	
Protection [EN 60529]	IP 40	
Connection	terminal screws	

Ex - Amplifiers

Series IKM 123 Ex

Gas $\text{Ex II (1) G [Ex ia Ga] IIC}$

Dust $\text{Ex II (1) D [Ex ia Da] IIIC}$

Cable break and short circuit monitoring

Connection to intrinsically safe 3-lead sensors

Output function programmable



Design	IKM 122 Ex...	
Dimensions		
ID-No.	P31335	P31336
Type	IKM 123 Ex-230	IKM 123 Ex-24
Output	 relay / change over	
Ex area of use	outside of the hazardous areas (gas or dust)	
Certificate No.	TÜV 11 ATEX 556280	
Ex marking	Gas: $\text{Ex II (1) G [Ex ia Ga] IIC}$ Dust: $\text{Ex II (1) D [Ex ia Da] IIIC}$	
Ambient temperature [°C]	$-20 \leq T_a \leq +60$	
Maximum values	$U_0 = 9.6 \text{ V} / I_0 = 50.5 \text{ mA} / P_0 = 121.3 \text{ mW} / C_0 = 0.68 \mu\text{F} / L_0 = 5.00 \text{ mH}$	
Supply voltage [V]	230 AC $\pm 10\%$	24 DC $\pm 10\%$
Switching voltage max [V]	250 AC / 60 DC / 24 DC	
Switching current max. [A]	4 AC / 0.8 DC / 4 DC	
Switching power	$\cos \varphi > 0.7 / L/R \leq 200 \text{ ms} / L/R \leq 200 \text{ ms}$	
Protection [EN 60529]	IP 40	
Connection	terminal screws	

Accessories • Mounting sleeves

It is not necessary to empty the vessel for routine sensor inspection.

PTFE housing for high chemical resistance

O-ring moisture barrier

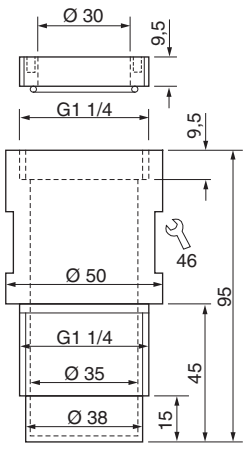
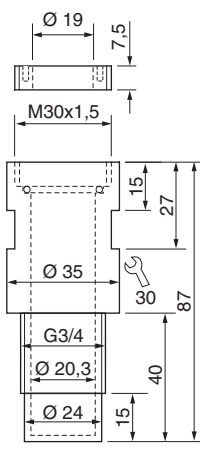
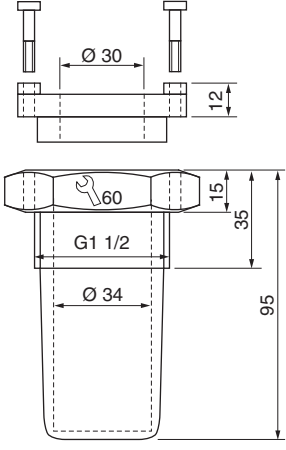

Design	KNM-35	KNM-20	KPM-35
Dimensions			
ID.-No.	P40501	P40500	P40502
Type	KNM-35	KNM-20	KPM-35
Housing material	PTFE	PTFE	Crastin
Torque max. [Nm]	1	1	3
Compressive strength [bar]	3	3	6
Thread	G1 1/4	G3/4	G1 1/2
For sensor type	KNK-025...	KNK-015...	KNK-025...
Usefully sensors	see in our catalogue „Capacitive Sensors“		

Fitting in of sleeves and sensors

Mounting sleeves are used for lateral or vertical passage through the vessel side. In order to ensure full pressure resistance, the thread should be screwed into the vessel threaded bush over a length of approximately 20 mm. If this is not possible because the vessel side is too thin, a suitable bush must be installed. However, the threaded passage should not be longer than the thread on the mounting sleeve. The interior thread must comply with DIN ISO 228. Sealing of the thread is either carried out with hemp and a sealing paste according to DIN-DVGW, or with PTFE sealing tape if higher chemical resistance is required. In any case, chemical resistance of the seal must be checked for this application. When screwing in the sleeve, maximum admissible torque must not be exceeded.

Metallic or metal clad vessels should be earthed. In the case of plastic vessels filled with electrically conductive materials, the latter should be earthed. In the case of plastic vessels filled with non-conducting materials, an earthed metal band applied on the outside of the vessel may be used as a counter electrode. For fitting the sensor, the closing ring is unscrewed from the

mounting sleeve. The sensor connecting cable must be fitted through the closing ring and the sensor fitted into the sleeve. After this, the closing ring is screwed back into the mounting sleeve, until the gasket is firmly pressed against the sensor housing. This ensures that no external humidity will penetrate into the mounting sleeve, as this might lead to sensor switching failures.

Sensor compensation

To start with, the plastic screw which protects the compensating potentiometer against humidity must be removed. The screwdriver blade used for compensation should be narrower than 2.4 mm. The sensor is now fitted into the sleeve, and the vessel filled to a level allowing for complete immersion of the sleeve. Beginning at the left limit, turn the potentiometer clockwise until the switching output is operated (NO), after which the potentiometer is turned further clockwise about one revolution. The switching output of the sensor should now be closed. In case of very small bulk densities and corresponding small dielectric constant, it may be necessary to turn only half a revolution.

Accessories • M12 connector

System SL

Finished cable plug housing
Self locking screw plug
Protection IP 67

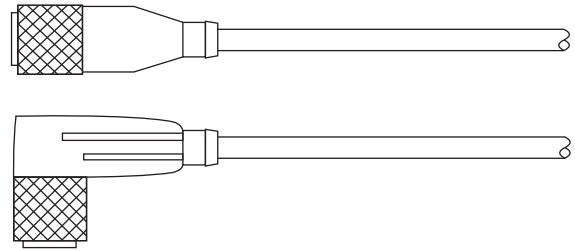

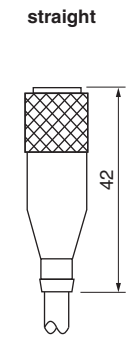
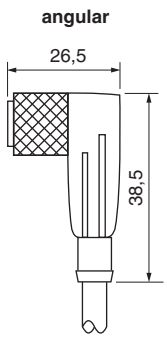
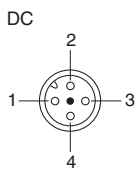
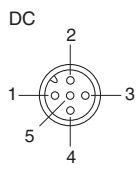
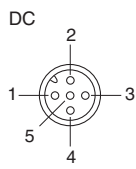
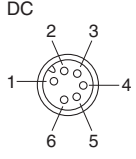
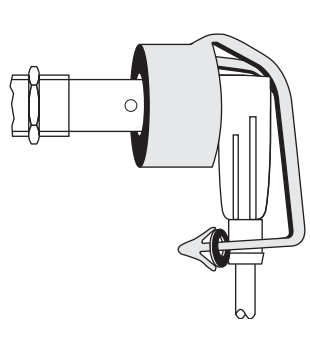
Cable plug housing	Pin-assignment	Plug-lock
<div style="display: flex; justify-content: space-around;"> <div style="text-align: center;"> <p>straight</p>  <p>42</p> <p>SLG...</p> </div> <div style="text-align: center;"> <p>angular</p>  <p>26,5 38,5</p> <p>SLW...</p> </div> </div>	<div style="display: flex; justify-content: space-around;"> <div style="text-align: center;"> <p>DC</p>  <p>3-wire 1: BN 2: - 3: BU 4: BK</p> </div> <div style="text-align: center;"> <p>DC</p>  <p>4-wire 1: BN 2: WH 3: BU 4: BK</p> </div> <div style="text-align: center;"> <p>DC</p>  <p>5-wire 1: BN 2: WH 3: BU 4: BK 5: GY</p> </div> <div style="text-align: center;"> <p>DC</p>  <p>6-wire 1: BN 2: WH 3: BU 4: BK 5: GY 6: PK</p> </div> </div>	 <p>PL-M12</p>
	DC	

TYPE	ID-NO.	DESIGN
SLG 3-2	Z01076	Cable plug housing straight, 2 m cable 3x0.34 mm ² max. 250 V / 4 A
SLG 3-5	Z01077	Cable plug housing straight, 5 m cable 3x0.34 mm ² max. 250 V / 4 A
SLW 3-2	Z01078	Cable plug housing angular, 2 m cable 3x0.34 mm ² max. 250 V / 4 A
SLW 3-5	Z01079	Cable plug housing angular, 5 m cable 3x0.34 mm ² max. 250 V / 4 A
SLW 3-2-LED	Z00052	Cable plug housing angular, 2 m cable 3x0.34 mm ² max. 250 V / 4 A PNP with LED
SLG 4-2	Z00445	Cable plug housing straight, 2 m cable 4x0.25 mm ² max. 250 V / 4 A
SLG 4-5	Z00449	Cable plug housing straight, 5 m cable 4x0.25 mm ² max. 250 V / 4 A
SLW 4-2	Z00446	Cable plug housing angular, 2 m cable 4x0.25 mm ² max. 250 V / 4 A
SLW 4-5	Z00450	Cable plug housing angular, 5 m cable 4x0.25 mm ² max. 250 V / 4 A
SLW 4-2-LED	Z01157	Cable plug housing angular, 2 m cable 4x0.25 mm ² max. 250 V / 4 A PNP with LED
SLG 5-2	Z01150	Cable plug housing straight, 2 m cable 5x0.34 mm ² max. 60 V / 2 A
SLW 5-2	Z01151	Cable plug housing angular, 2 m cable 5x0.34 mm ² max. 60 V / 2 A
SLG 6-2	Z01197	Cable plug housing straight, 2 m cable 6x0.25 mm ² max. 36 V / 2 A
SLW 6-2	Z01198	Cable plug housing angular, 2 m cable 6x0.25 mm ² max. 36 V / 2 A
PL-M12	Z01182	Plug-lock for sensors in Ex areas

DATA

Thread	M12x1	Contact resistance	≤ 5 mΩ
Material	PVC	Insulation resistance	>10 ⁹
Protection	IP 67	Testing voltage	2.0 KV eff. / 5 and 6 pol. 1.5 KV eff.
Temperature range	-25...+80 °C		

Note

Sensors with NC output are connected to 4 pole cable plug housings. In this case, the break output is connected to the white lead (connection 2).

Accessories • Assembly parts

Lock nuts, brass-nickel - plated

ID-NO.	Z00106	Z00107	Z00114	Z00109	Z00110
Nut thickness [mm]	4	4	4	5	5
Thread	M12x1	M18x1	M22x1	M30x1.5	M38x1.5
Spanner size	17	24	27	36	50

Lock nuts, special steel

ID-NO.	Z01098	Z00112	Z00113	Z00115
Nut thickness [mm]	4	4	4	5
Thread	M8x1	M12x1	M18x1	M30x1.5
Spanner size	13	17	24	36

Lock nuts, plastics

ID-NO.	Z00180	Z00120	Z00117	Z00118	Z00119	Z01092	Z01052
Nut thickness [mm]	6	8	4	5	5,5	8	8
Thread	M14x1	M30x1.5	M12x1	M18x1	M30x1.5	G 3/4	G 1
Spanner size	22	41	17	24	36	41	50
Material	PTFE	PTFE	PPE	PPE	PPE	PTFE	PTFE

Central screw, polyamide

Z00104	M12, length 70 mm, hexagon socket 10 mm, material PA
Z00105	M16, length 90 mm, hexagon socket 14 mm, material PA

MOUNTING CLAMPS

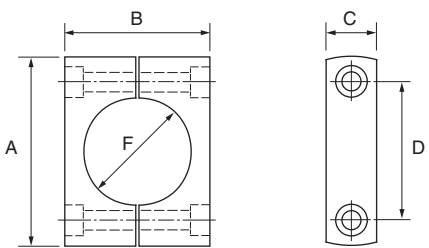
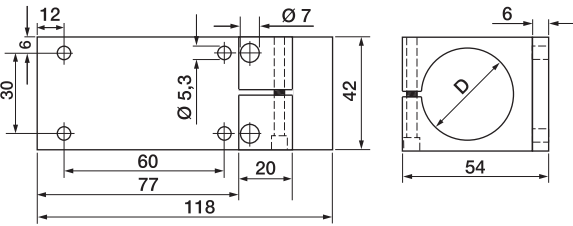
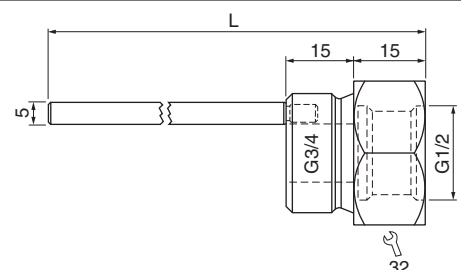
TYPE	ID-NO.	DIMENSIONS	DESIGN																		
KLS 20 KLS 34	Ø 20 Ø 34	Z00100 Z00102	Clamps of PA, for smooth-bodied switches																		
		 <p>E: hexagon socket screw 1.4305</p>	<table border="1"> <thead> <tr> <th>F</th> <th>Ø 20</th> <th>Ø 34</th> </tr> </thead> <tbody> <tr> <td>A</td> <td>47</td> <td>61</td> </tr> <tr> <td>B</td> <td>30</td> <td>47</td> </tr> <tr> <td>C</td> <td>17</td> <td>15</td> </tr> <tr> <td>D</td> <td>32</td> <td>45</td> </tr> <tr> <td>E</td> <td>M5x30</td> <td>M5x50</td> </tr> </tbody> </table>	F	Ø 20	Ø 34	A	47	61	B	30	47	C	17	15	D	32	45	E	M5x30	M5x50
F	Ø 20	Ø 34																			
A	47	61																			
B	30	47																			
C	17	15																			
D	32	45																			
E	M5x30	M5x50																			
KBM 025 KBM 030 KBM 035	Ø 25 Ø 30 Ø 35	Z01189 Z01188 Z01187	Mounting clamp of Aluminium																		
			<table border="1"> <thead> <tr> <th>Type</th> <th>D</th> </tr> </thead> <tbody> <tr> <td>KBM 025</td> <td>Ø 25</td> </tr> <tr> <td>KBM 030</td> <td>Ø 30</td> </tr> <tr> <td>KBM 035</td> <td>Ø 35</td> </tr> </tbody> </table>	Type	D	KBM 025	Ø 25	KBM 030	Ø 30	KBM 035	Ø 35										
Type	D																				
KBM 025	Ø 25																				
KBM 030	Ø 30																				
KBM 035	Ø 35																				
Screw-on-electrode L = 330 mm L = 530 mm L = 1030 mm	Z01205 Z01206 Z01207		Sensor: CFC 050 GSOP Material: AISI 316 Ti For the use in plastic containers																		

A selection

Flow sensors

- Electronical monitoring of flow
- Lubrication monitoring
- Measuring range 1 ml/min...100 l/min
- Detection range 1...300 cm/s
- Reaction time 0.5 s

Ultrasonic sensors

- Switching distance up to 6000 mm
- Level monitoring
- Watertight housing
- Teach-in functions

Pressure sensors

- Monitoring in pipes and containers
- Pressure up to 16 bar
- Level up to 10 m (± 1 cm)
- Compact models
- Programmable

Temperature sensors

- Monitoring in pipes and containers
- Temperature $-40...+120$ °C ($\pm 0,3$ °C)
- Pressure up to 100 bar
- Compact models
- Multi use output NO/NC + analog

Infrared detectors

- Measurement of temperature
- Monitoring of hot media
- Position control

Metal detectors

- Detection of metal parts
- For harsh environment
- Large sensing range up to 400 mm
- Monitoring of bulk materials
- Machine protection





Headquarters
EGE-Elektronik
Spezial-Sensoren GmbH

Ravensberg 34
D-24214 Gettorf
Tel. +49 (0) 4346 / 41580
Fax +49 (0) 4346 / 5658

Internet: www.ege-elektronik.com



EGE-Elektronik ApS
Forstallé 79
DK-6200 Aabenraa
Tel. +45 70207271
Fax +45 70207272



EGE-Specialsensorer AB
Stationsgatan 4
S-51250 Svenljunga
Tel. +46 32512060
Fax +46 32512064



Stork AS
Brynsveien 100
N-1352 Kolsås
Tel. +47 67176400
Fax +47 67176401



Vision Systems OY
PL353
FI-40101 Jyväskylä
Tel. +358 (0)10 322 7100
Fax +358 (0)10 322 7119



Molex France
18 Parc Burospace
F-91571 Bièvres Cedex
Tel. +33 2 32 96 04 28
Fax +33 2 32 96 04 21



Cematic-Electric B.V.
Spinel 200
NL-3316 LG Dordrecht
Telefon +31 74 2433422
Telefax +31 74 2913333



ICM Ital Control Meters Srl
Via della Valle 67
I-20048 Carate Brianza (Mi)
Tel. +39 0362 8052 00
Fax +39 0362 8052 01



Bibus Spain, S. L.
Rúa do Arroncal, Vial C – Nave 4A
ES-36350 Nigran
Tel. +34 986 247286
Fax +34 986 209247



Powelectrics Limited
Sandy Hill Park, Sandy Way
Amington, Tamworth
GB-Staffordshire B77 4DU
Tel. +44 1827310666
Fax +44 1827310999



Bachofen AG
Ackerstraße 42
CH-8610 Uster
Tel. +41 449441111
Fax +41 449441233



VWR International GmbH
Graumannsgasse 7
A-1150 Wien
Tel. +43 1 97 002 - 0
Fax +43 1 97 002 - 600



Countapulse Controls (PTY) LTD.
P.O.B. 40393
ZA-2022 Cleveland
Tel. +27 116157556
Fax +27 116157513



HITECH Ltd.
1-35-2 Simouma, Setagaya,
JPN-Tokyo 154-0002
Tel. +81 35430 2301
Fax +81 35430 2302



Micromax S&A P/L
Unit 2 106-110 Beaconsfield Street
AUS-Silverwater NSW 2128
Tel. +61 1300 362626
Fax +61 1300 017100



**PROTEK TEKNİK ELEKTRİK
TİC.SAN.LTD.ŞTİ.**
Okçumusa Cad. Kismet Han
No: 36/2 P.K.
TR-34420 Karaköy-Istanbul
Tel. +90 212 237 20 00
Fax +90 212 235 46 09



IAC & Associates
2180 Fasan Drive
Oldcastle
CDN-Ontario N0R 1L0
Tel. +1 519 7370311
Fax +1 519 7370314
TF +1 800 711 1900



Yuden-Tech Co., Ltd.
5F., No. 121, Lide St.,
Zhonghe City, Taipei County 235,
Taiwan (R.O.C.)
Tel. +886 2 8221 2958
Fax +886 2 8221 2492



**Shanghai Beishidietian
Business Trade Co., Ltd.**
4F, No. 88-1, Lane 7039,
Zhongchun Rd., Minhang Area
Shanghai City
Tel. +86 21 54887307
Fax +86 21 54887305



CSE-W. Arthur Fischer Ltd.
15 Polaris Place, Greenmount
NZ-East Tamaki, Auckland
Tel. +64 9271 3810
Fax +64 9265 1362



KOLEKTOR SISTEH d.o.o.
Šlandrova ulica 10
SI-1231 Ljubljana - Črnuče
Slovenija
Tel. +386 1 5636 300
Fax +386 1 7227 930



Introl Sp. z o.o.
ul. Kościuszki 112
40-519 Katowice
Tel. +48 32 789 00 00
Fax +48 32 205 33 77



Bibus Portugal, LDA
Centro Empresarial AAA
Rua Ponte da Pedra, 240 - C4
4470-108 Gueifães - Maia
Porto
Tel. +351 22 906 50 50
Fax +351 22 906 50 53



Futron Electronics PTE Ltd.
1004 Toa Payoh North
#04-08/09/10
Singapore 318995
Tel. +65 6250 2456
Fax +65 6250 6592



Useong Electrade Co.,
D-1006, Technopark
No. 1345, Soha-dong, Gwangmyeong-si
Gyeonggi-do,
Korea
Tel. +82 (0) 2 2686 7314
Fax +82 (0) 2 2686 7316