

DALI® Power Module

The DALI® Power Module is a DIN-rail mounted controller for DALI®-compliant digital addressable loads, referred to as control gear. It provides DALI® bus power and control for two independent DALI® buses with up to 64 DALI-compliant digital addressable loads each.

Model Number

LQSE-2DAL-D: 2-link DALI® fixture controller

Features

- Provides power for two buses of DALI®-compliant digital addressable loads:
 - 128 mA guaranteed current
 - 250 mA maximum supply current per bus
- Each DALI® bus can control a maximum of 16 zones.
- Power failure memory retains programming in the event of a power loss.
- DALI® Power Module can be used in a HomeWorks QS system to control and manage light in an entire home or building.

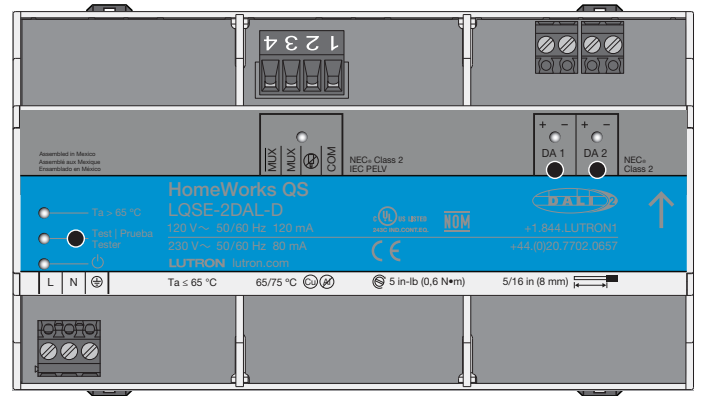

DALI® Power Module (LQSE-2DAL-D)

DALI® Compatibility

The Lutron DALI® Power Module is DALI-2® certified by the Digital Illumination Interface Alliance (DiiA®). In order to ensure compatibility with Lutron DALI® controllers, the connected DALI® LED drivers and fluorescent ballasts must be DALI-2® certified and marked. In addition to compatibility, it is important to select high-quality and high-performance LED drivers and fluorescent ballasts. DALI-2® certified devices are readily available from many manufacturers and are tested for compatibility with the standard. For a complete list of available DALI-2® certified devices, see the DiiA® website at <https://www.digitalilluminationinterface.org/products>. DALI® devices that are not listed on the DiiA® website and are not marked DALI-2® cannot be considered DALI-2® certified.

The DALI® version-1 standard does not ensure compatibility. To apply the original DALI® version-1 mark on LED drivers and fluorescent ballasts, no verification of the test results was required, and manufacturers could self-declare compliance and apply the DAL® mark. If you would like to use an LED driver or fluorescent ballast that is not DALI-2® certified but carries a DALI® version-1 logo, Lutron recommends that these devices be tested to ensure compatibility. Lutron is able to perform this testing on request. Samples of the drivers and light engines must be submitted to Lutron and the expected turnaround time is 6 to 8 weeks after the drivers are received. Fees for testing may apply. Lutron recommends that this testing be performed before the fixtures and lighting controls are purchased and installed. Contact your Lutron sales representative for more information.

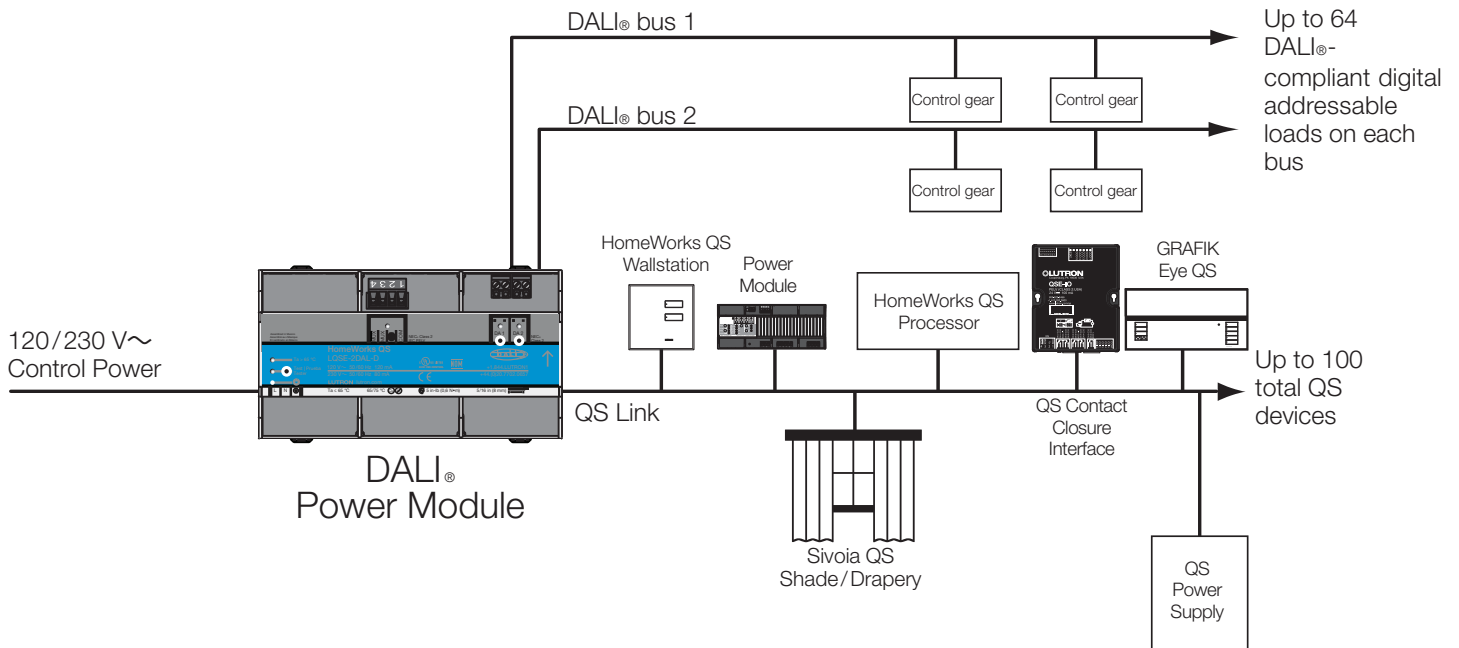

Job Name:	Model Numbers:
Job Number:	

Specifications

Power

- 120 V~ 50/60 Hz 120 mA
- 230 V~ 50/60 Hz 80 mA
- Lightning strike protection meets ANSI/IEEE standard 62.31-1980. Can withstand voltage surges of up to 6000 V~ and current surges of up to 3000 A.
- Stand by power: 7 W
- BTUs/hour when fully loaded: 24
- DALI® bus Output: 16 V $\overline{=}$ 128 mA guaranteed supply current, 250 mA maximum supply current per bus.

Standards

- Lutron Quality Systems registered to ISO 9001:2015.
- IEC 60669-2-1
- DALI-2® Certified
- UL
- cUL
- NOM

Environment

- Surrounding Air Temperature Range: 0 °C to 65 °C (32 °F to 149 °F).
- Relative Humidity: less than 90% non-condensing.
- Calibration point maximum: 75 °C (167 °F)
- For indoor use only.

Terminals

- Mains Wiring: 1.0 mm² to 4.0 mm² (18 AWG to 10 AWG)
- DALI® bus Wiring: 0.5 mm² to 4.0 mm² (20 AWG to 10 AWG)
- QS Link Wiring: 0.5 mm² to 4.0 mm² (20 AWG to 10 AWG)
- Minimum wire temperature rating = 65 °C (149 °F), copper wire only

Mounting

- Mount in a Lutron DIN Panel (see spec 369788) or in an IP20 (minimum) rated consumer panel or breaker panel with integrated DIN rail.
- Width = 9 DIN modules (161.7 mm or 6 3/8 in).
- For more information on mounting and installation in panels with integrated DIN rail see Lutron P/N 048466 at www.lutron.com

Programming and Compatibility Requirements

- The LQSE-2DAL-D can only be used with the HomeWorks QS system.
- Setup and programming of the DALI® Power Module is done through the HomeWorks QS programming software.

DALI® Buses

- Up to 64 DALI® compliant loads on each bus can be addressed and grouped into 16 zones.
- DALI® Power Module supplies a maximum of 250 mA to power each bus.
- DALI® Power Module supplies a guaranteed current of 128 mA to power each bus.
- DALI® Power Module has an integrated bus power supply with polarity indicated on the unit.
- Some DALI® loads may be polarity sensitive. Refer to individual manufacturers' specifications for proper connection to the DALI® bus.
- Short circuit protection with automatic restart.

QS Link Limits

- A QS link in a HomeWorks QS system can have up to 512 zones (outputs) and 100 devices. A DALI® compliant digital addressable load counts as 1 zone unless specifically grouped into zones from the HomeWorks QS software.
- Each DALI® Power Module counts as one device toward the 100 device limit.
- A maximum of 8 fully loaded DALI® buses may be connected to a single QS link.

HomeWorks QS Wallstations

- HomeWorks QS wallstations can be configured to control DALI® Power Modules with the HomeWorks QS programming utility.
- LED indicator displays the status of programmed lights.

Troubleshooting and Maintenance Features

- Maintains redundant memory of control gear programming for ease of single or multiple control gear replacement.
- To verify DALI® lights connected to DALI® bus 1 and bus 2:
 - **Enter Test Mode:** Press and hold **Test** button on the DALI® Power Module until the Test LED starts flashing.
 - **Test:** Each press of either the **DALI® version-1** or **DALI-2®** button will cycle the lights between high-end, low-end, flash and off for that bus.
 - **Exit Test Mode:** Press and hold **Test** button until Test LED stops flashing.

Job Name:	Model Numbers:
Job Number:	

Overview of Wiring Terminals and Mechanical Dimensions

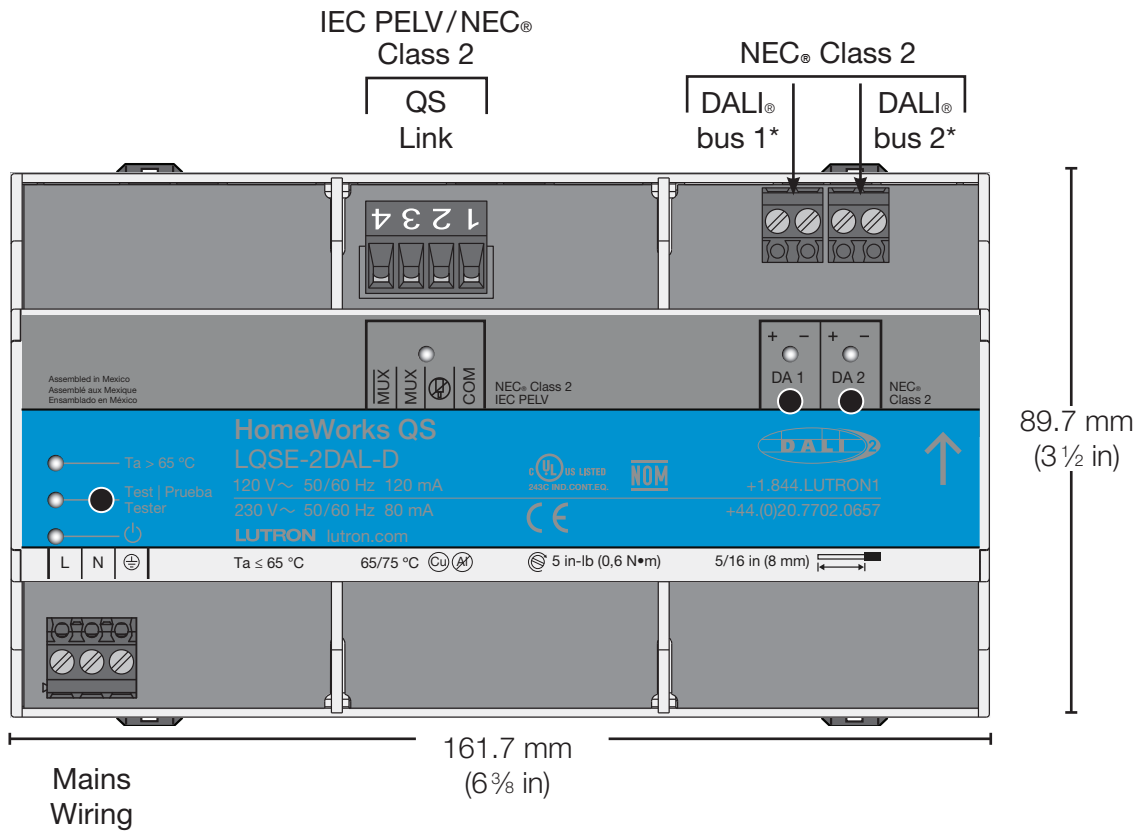

* Wire according to local codes.

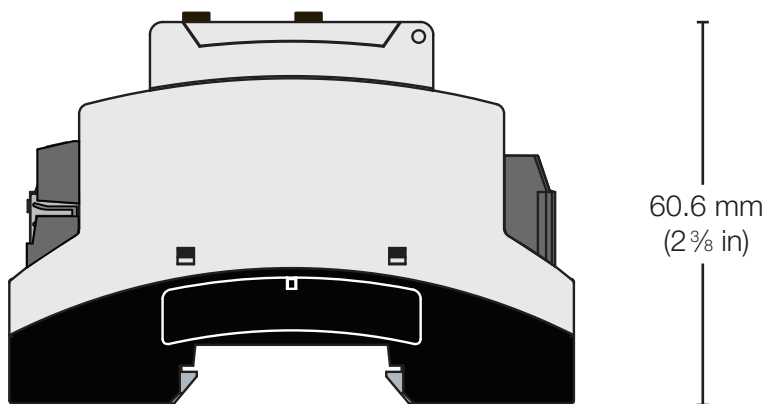

Job Name:	Model Numbers:
Job Number:	

Wiring: Mains Voltage

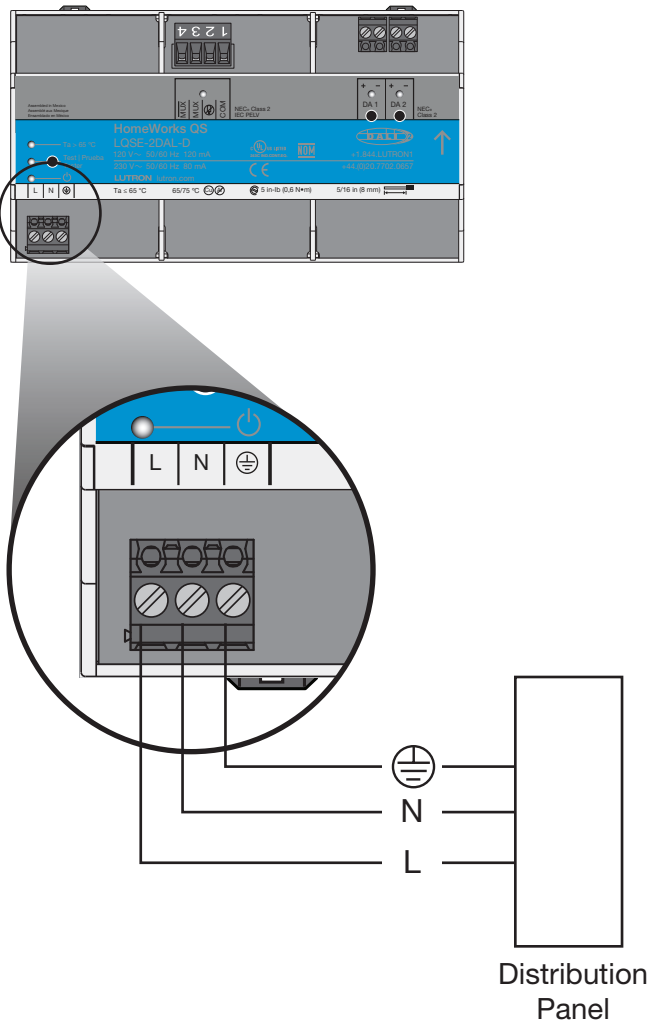

⊕ – Earth/Ground
 N – Neutral
 L – Mains/Line

Wiring from Distribution to Power Module

- Turn off all circuit breakers or isolators feeding the Power Module unit at the distribution panel.
- Run line, neutral, and earth/ground (⊕) wires from a feed to the DALI® Power Module.
- Use 1.0 mm² to 4.0 mm² (18 AWG to 12 AWG) conductors (depending on breaker rating) to feed the mains wiring. The device draws less than 120 mA (120 V~) and 80 mA (230 V~).

Emergency Lighting Applications

- Use normal (non-essential) power only to power the DALI® Power Module.
- When normal power drops out, the DALI® Power Module will not power the DALI® buses. When this occurs, control gear powered from emergency feeds go to their emergency mode (full light output by default).

Mains Wiring and IEC PELV/NEC® Class 2 Separation

- The DALI® Power Module is designed to separate mains wiring from IEC PELV/NEC® Class 2 circuits.
- Follow appropriate local and national codes to avoid violating required separation guidelines.

Job Name:	Model Numbers:
Job Number:	

Wiring: DALI Bus

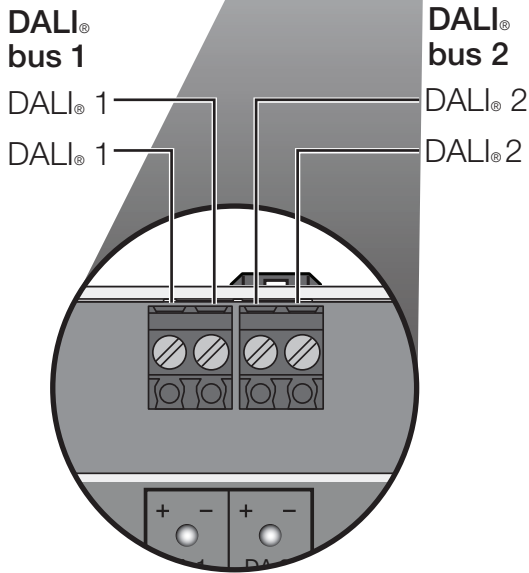
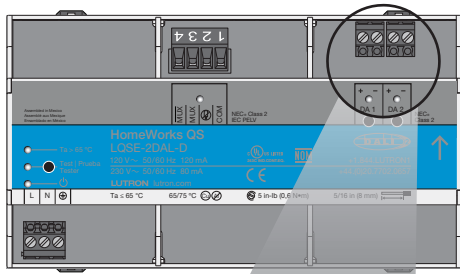

The DALI® Power Module will supply power for two independent DALI® buses, which supports a maximum of 64 DALI®-compliant digital addressable loads per bus.

DALI® Wiring

- DALI® wiring is not SELV.
- DALI® wiring may be treated as mains voltage, and thus can be run within the same sheathing.
- Ensure that there is no greater than a 2 V~ drop between the DALI® Power Module and the end of the DALI® bus.
- Consult all national and local electrical codes for separation requirements.

Wire Gauge	Maximum DALI®-compliant Bus Wire Length
1.5 mm ² (14 AWG)	300 m (984 ft)
0.75 mm ² (18 AWG)	150 m (492 ft)
0.5 mm ² (20 AWG)	100 m (328 ft)

Job Name:	Model Numbers:
Job Number:	

Wiring: QS Link

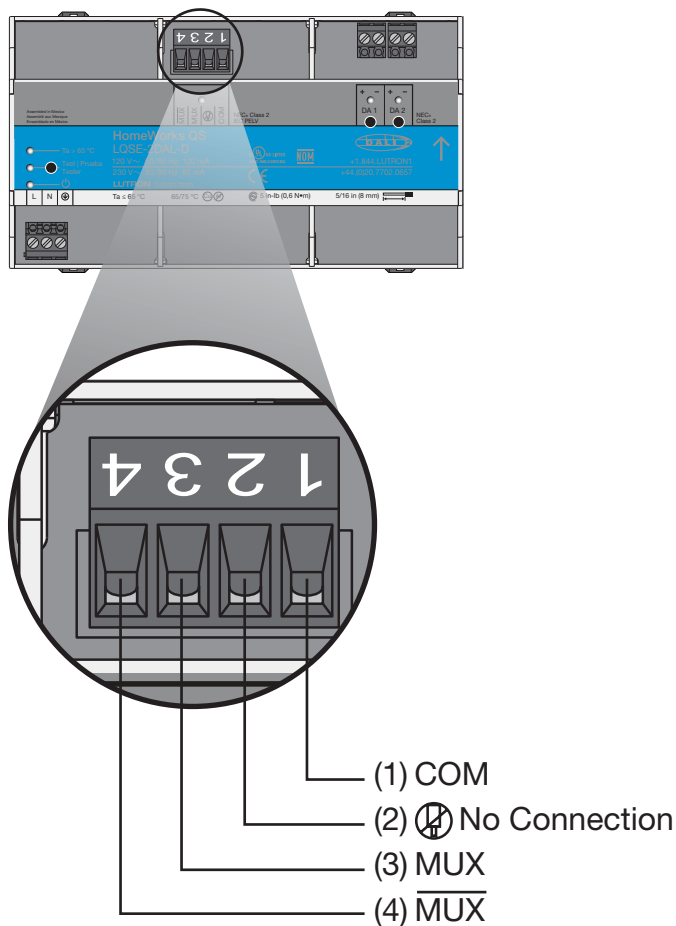

IEC PELV/NEC® Class 2 QS Link Wiring

- Link communicates using IEC PELV/NEC® Class 2 wiring.
- Follow all applicable national and local codes for proper circuit separation and protection.
- Wiring may be daisy chained or t-tapped.
- Do NOT connect terminal 2.
- Total length of QS link must not exceed 610 m (2000 ft).
- Use one, twisted-shielded pair of 0.5 mm² (20 AWG) for data link (MUX, MUX).

QS Link Wiring Length	Wire Gauge	Available from Lutron in one cable:
Less than 153 m (500 ft)	Power (terminals 1 and 2): 1 pair 1.0 mm ² (18 AWG)	GRX-CBL-346S (non plenum)
	Data (terminals 3 and 4): 1 pair 0.5 mm ² (20 AWG), twisted and shielded	GRX-PCBL-346S (plenum)
153 m to 610 m (500 to 2000 ft)	Power (terminals 1 and 2): 1 pair 4.0 mm ² (10 AWG)	GRX-CBL-46L (non plenum)
	Data (terminals 3 and 4): 1 pair 0.5 mm ² (20 AWG), twisted and shielded	GRX-PCBL-46L (plenum)

Lutron, Lutron, HomeWorks, Sivoia, and GRAFIK Eye are trademarks or registered trademarks of Lutron Electronics Co., Inc. in the US and/or other countries.

All other product names, logos, and brands are property of their respective owners.

Job Name:	Model Numbers:
Job Number:	